

Lightgap – Emphasising wall structures for a three-dimensional effect

Grazing light wallwashers accentuate surface texture on walls

Lightgap emphasises the tactile qualities of architectural materials by making even the finest structures of wood, concrete and rough surfaces such as natural stone clearly visible. This creates high-contrast, structurally appealing effects with light and shadow. Lightgap generates an extremely uniform beam even when positioned up to 10cm in front of the wall. The light can be comfortably tilted in both directions up to an inclination angle of 10 degrees. Lightgap thus offers striking tex-

ture effects and is also ideal for efficient room lighting, for example in restaurants and hotels.



Structure and characteristics

The features described here are typical of products in this range. Special versions may offer additional or varying features. A comprehensive description of the features of individual products can be found on our website.

1 ERCO Spherolit lens

2 ERCO LED-module

- High-power LEDs: warm white (2700K or 3000K) or neutral white (3500K or 4000K)
- Collimating lens made of optical polymer

3 Housing

- Aluminium profile
- Arrangement as continuous band of light possible
- Fixing clip: metal, black powder-coated

4 Control gear

- Switchable, DALI dimmable or Casambi Bluetooth

Variants on request

- Connection: 3- or 5-pole plug with connection cable (Wago or Wieland)
 - Housing: 10,000 further colours
- Please contact your ERCO consultant.



Design and application:
www.erco.com/lightgap

Lightgap Recessed luminaires

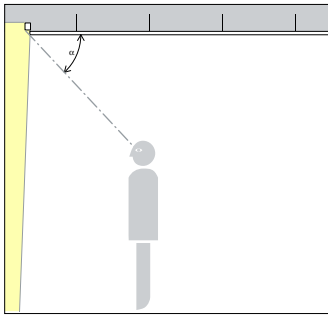

Very high visual comfort

Due to the small installation dimensions of Lightgap grazing light wallwashers, the luminaires remain concealed and thus support ideal visual comfort. The shielding angle (a) of Lightgap depends on the ceiling height.

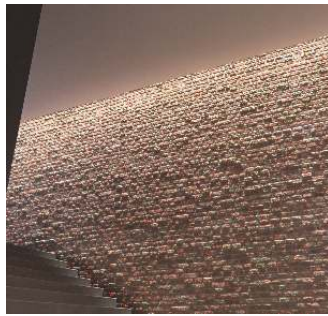

Grazing light wallwasher

The especially narrow light distribution of the grazing light wallwashers at short distances from the wall displays relief surfaces in a high quality and uniform way.

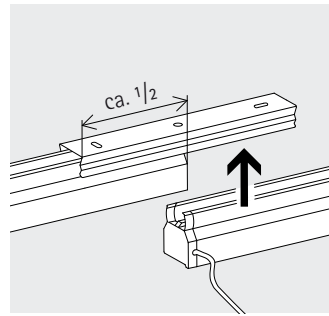

Continuous line arrangements are possible

Lightgap luminaires can be mounted directly together to achieve a very uniform distribution of brightness on the wall.

Special characteristics



Excellent visual comfort



Grazing light wallwasher



Continuous line arrangements are possible



ERCO high-power LEDs



Efficient Spherolit technology



Different light colours



Excellent thermal management



EMC-optimised



Various construction sizes



Pivotable by $\pm 10^\circ$



Very good price performance ratio



Switchable



DALI dimmable



Casambi Bluetooth

Lightgap Recessed luminaires – Luminaire arrangement

Grazing light wallwashers Grazing light

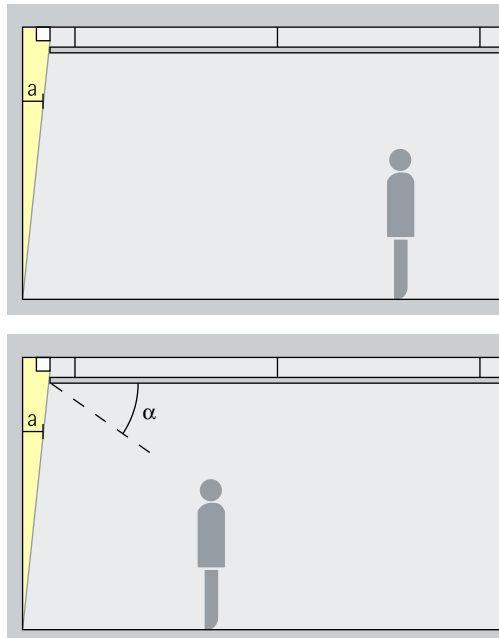

Wallwashing

To allow surface textures to come to the foreground of attention, the distance (a) of Lightgap grazing light wallwashers from the wall should be at least 10cm.

Arrangement: $a > 10\text{cm}$

Application: surfaces with a three-dimensional texture, e.g. natural stone walls in prestigious areas.

The shielding angle (α) depends on the position of the suspended ceiling and the size of the cove lighting. A small opening between wall and dry construction narrows the beam on the ground.



Buckford Illumination Group, Melbourne. Architecture and lighting design: Buckford Illumination Group. Photography: Jackie Chan, Sydney.

Lightgap Mounting notes

Grazing light wallwashers accentuate surface texture on walls

Lightgap emphasises the tactile qualities of architectural materials. The grazing light wallwasher brings out the finest wood or concrete texture as exquisitely as rough surfaces such as natural stone, thereby enabling the luminaire to emphasise historic features or regional materials. In contrast to conventional wallwashers, which give walls a soft character, Lightgap adds an almost tactile dimension through high-contrast light and shadow effects. With its asymmetrical light distribution, the grazing light wallwasher can be positioned up to 10cm close to the wall and still produce an exceptionally uniform beam. The luminaire can be tilted conveniently by up to 10° in both directions. The resulting special rendering of vertical illuminance combines strikingly illuminated texture for scenic effects with efficient room lighting for places such as restaurants and hotels.

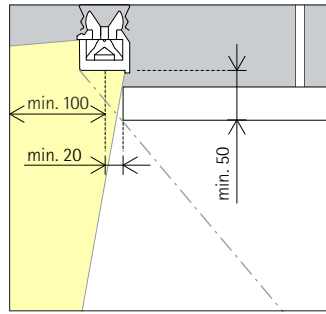
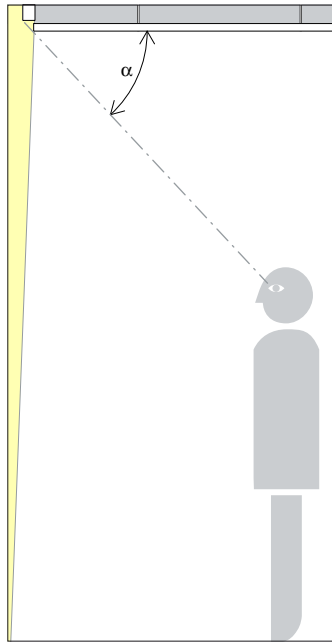

Dry construction defines light effect

The dry construction detail of the suspended ceiling is used to manipulate the emission angle of grazing light wallwashers.

A small opening between wall and dry construction narrows the beam on the ground.

Excellent visual comfort

The shallow recess depth of the Lightgap grazing light wallwasher keeps the luminaire concealed to ensure excellent visual comfort.

The shielding angle (α) depends on the position of the suspended ceiling and the size of the cove lighting.

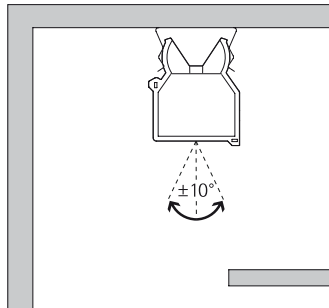

Tiltable by 10°

After installation, Lightgap can be tilted by +/- 10° within the mounting profile to optimise the light distribution along the wall.

Grazing light wallwashers

The very narrow light distribution of the grazing light wallwashers positioned close to the wall uniformly illuminates relief-like surfaces, making elegant materials highly visible.

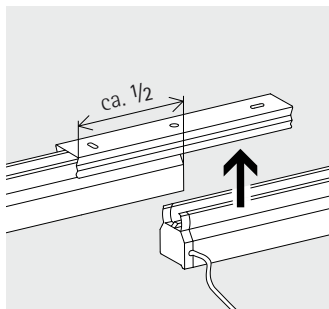
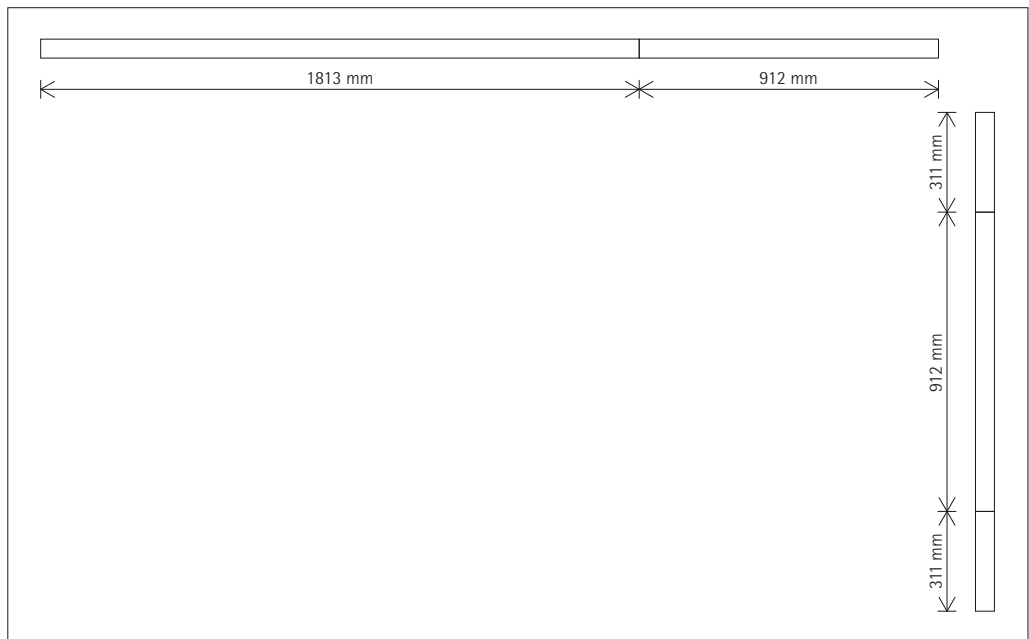

Continuous line installation

The Lightgap luminaires can be installed in a continuous line to achieve maximised and uniform illuminance distribution on the wall.

System design

The Lightgap lighting system is available in three lengths for different room layouts. When arranged end to end in a continuous row, the individual luminaires create an elegant and uniform band of light along the wall.

Lightgap Recessed luminaires

Construction size 311mm

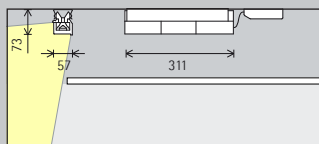

Construction size 912mm

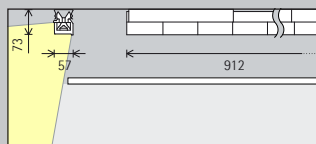

LED module
Maximum value
at 4000K CRI 82

6W/825lm

18W/2475lm

Light colour

	2700K CRI 92		3500K CRI 92
	3000K CRI 92		4000K CRI 82
	3000K CRI 97		4000K CRI 92

	2700K CRI 92		3500K CRI 92
	3000K CRI 92		4000K CRI 82
	3000K CRI 97		4000K CRI 92

Light distribution

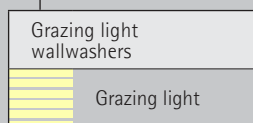
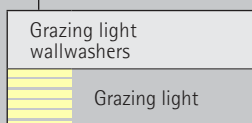

Control

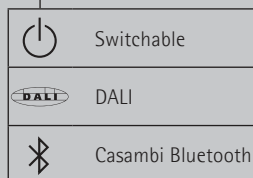
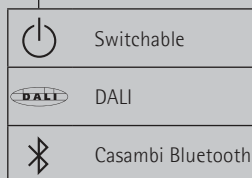



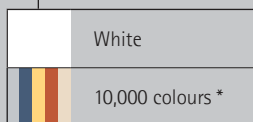

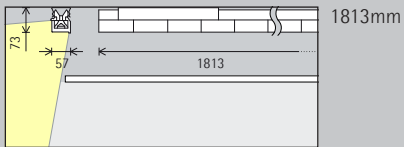

Colour (housing)







36W/4950lm

	2700K CRI 92		3500K CRI 92
	3000K CRI 92		4000K CRI 82
	3000K CRI 97		4000K CRI 92

Grazing light wallwashers



Grazing light

 Switchable

 DALI

 White

 10,000 colours *

* available on request

Article numbers and planning data:
www.erco.com/015203

Design and application:
www.erco.com/lightgap



