

Quintessence round – The system solution for excellent visual comfort

High visual comfort and optimum light quality – in indoor and outdoor areas

Quintessence recessed luminaires take the visual comfort and the light quality of downlights, wallwashers and directional luminaires into the outdoor area. The optical systems of the downlights and wallwashers achieve high uniformity with good glare control, making them superb for extensive illumination in large areas. The exceptionally wide light distribution of the downlights with a 90° beam angle and a 40° cut-off produces highly uniform and glare-

free light, with luminaires that are spaced far apart. For precise accentuation, the optical system of the directional luminaires can be tilted by 20° and rotated through 360°. With a protection rating of IP65, Quintessence recessed luminaires are the efficient lighting tool for perception-orientated lighting concepts in outdoor areas with canopies and for indoor applications that call for a high degree of protection against moisture and dust.

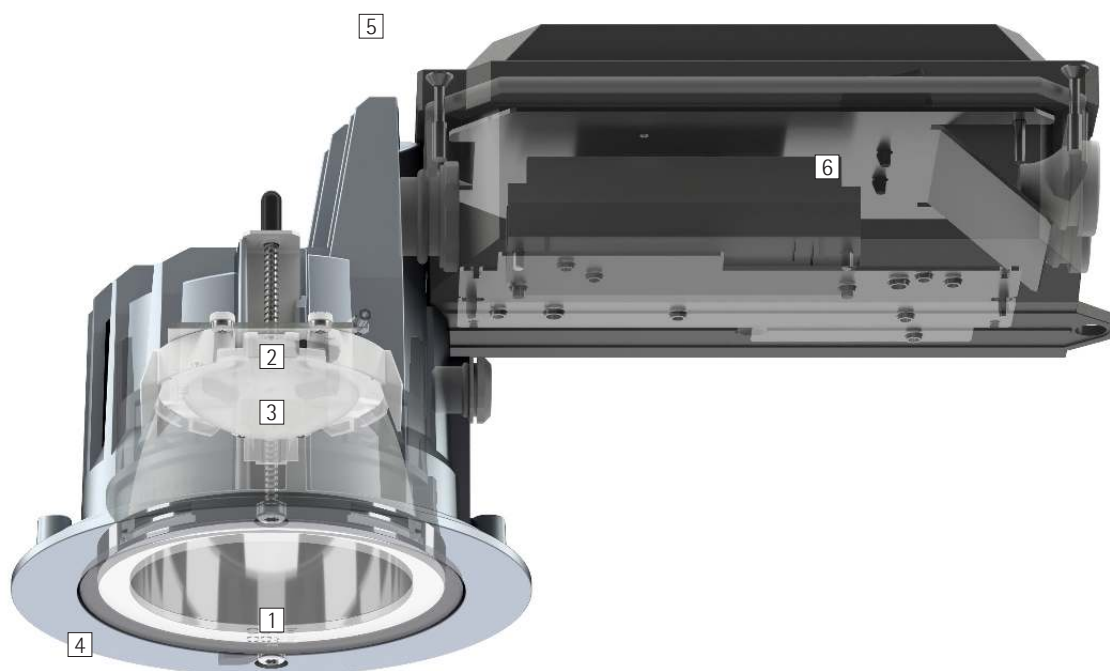

Structure and characteristics

The features described here are typical of products in this range. Special versions may offer additional or varying features. A comprehensive description of the features of individual products can be found on our website.

1 ERCO low brightness reflector

- Downlight: cut-off angle 40° from horizontal
- Polymer, aluminum vaporized, specular

or

Wallwasher reflector

- Cut-off angle 80° from horizontal
- Polymer, aluminum vaporized, specular

2 ERCO LED-module

- High-power LEDs: warm white (3000K) or neutral white (4000K)
- Directional luminaire with collimating lens made of optical polymer: 0°-20° tilt, 360° rotation

3 Diffuser or lens

- Made of optical polymer
- Diffuser lens, extra wide flood or lens system, wallwash
- Directional luminaire with Spherolit lens narrow spot, spot or flood

4 Cover ring

- Corrosion-resistant cast aluminum, No-Rinse surface treatment
- Silver, double powder-coated
- Safety glass

5 Housing

- Cast aluminum, powder-coated silver
- Mounting with 2- or 3-point contact and screw fastening. Max. ceiling thickness 1 3/16"
- Side-attached installation unit: polymer, black

6 Control gear

- Trailing edge dimmable
- Operation at 120V: Dimming with external dimmers possible
- Operation at 277V: switchable

Suitable for wet locations (IP65)

Dust-proof and water jet-proof

Variants on request

- High-power LEDs: 3000K CRI 97 or 2700K, 3500K, 4000K with CRI 92
 - Reflector: coated matt gold, matt silver or matt champagne
- Please contact your ERCO consultant.



Design and application:
www.erco.com/quintessence-o

Quintessence round Recessed luminaires

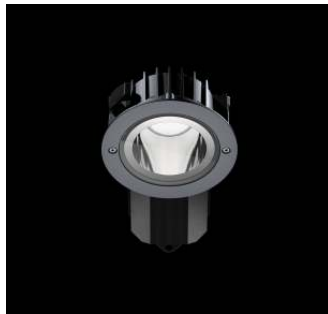

Very high visual comfort

The low brightness reflector combines maximum visual comfort with an optimum light output ratio.

Special characteristics



Excellent visual comfort



ERCO high-power LEDs



Excellent thermal management



Switchable



Cut-off 40°/80° from horizontal



EMC-optimized



Trailing edge dimmable



Different light distributions



Various construction sizes



Different light colors



Wet location

Quintessence round Recessed luminaires – Luminaire arrangement

Downlights Extra wide flood

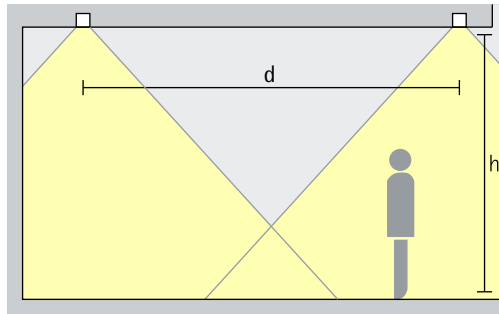

General lighting
For uniform ambient lighting, the spacing (d) between two Quintessence downlights may be up to approximately 1.5 times the height (h) of the luminaire above the working plane.

Arrangement: $d \leq 1.5 \times h$

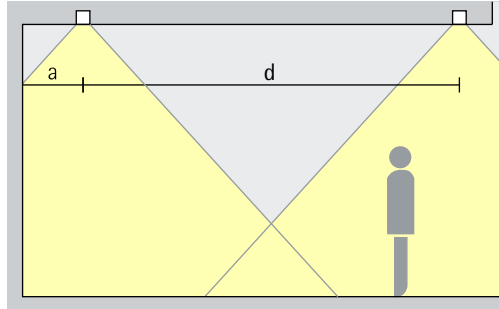

The wall offset should be half the luminaire spacing.

Arrangement: $a = d / 2$

Lens wallwashers Wallwash

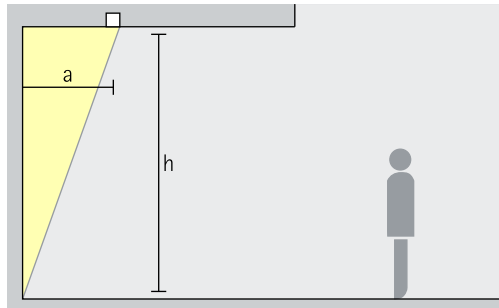

Wallwashing
For uniform vertical illuminance, the distance (a) of Quintessence lens wallwashers from the wall should be around one third of the room height (h).

Arrangement: $a = 1/3 \times h$

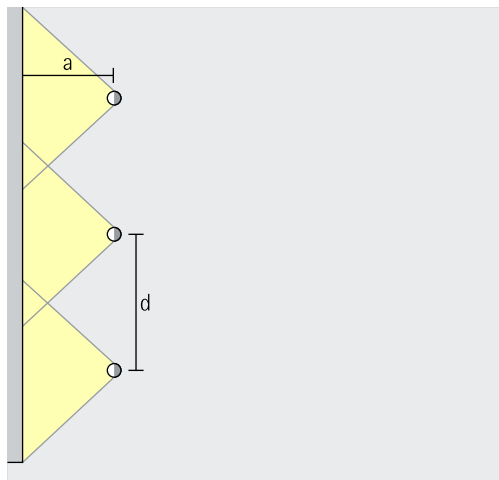

For good longitudinal uniformity, the spacing (d) of Quintessence lens wallwashers may be up to 1.3 times the offset from the wall (a).

Arrangement: $d \leq 1.3 \times a$

The optimal wall offset and luminaire spacing for each product are indicated in the wallwasher tables in the catalogue and the product data sheets.

Directional luminaires Narrow spot, Spot, Flood

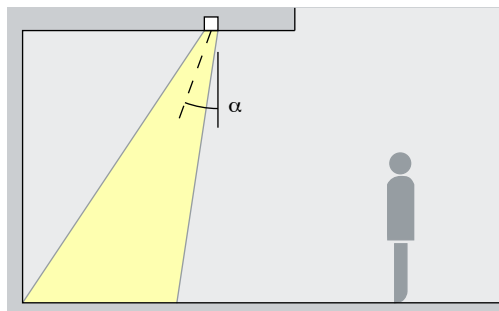

Accentuation
Quintessence directional luminaires accentuate artwork, products and architectural details effectively. The ideal angle of tilt (α) for this is around 20°. The object is modelled without distorting the effect as a result of excessive shadowing. It also prevents shadows cast by the observer.

Arrangement: $\alpha = 20^\circ$

AstraZeneca
Central Operations,
Södertälje.
Architect: Lomar
Arkitekter AB,
Stockholm.



Quintessence round Recessed luminaires

Construction size

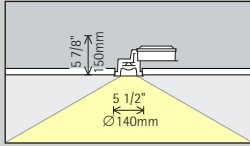

Size 3

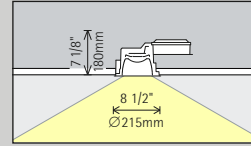

Size 5

LED module
Maximum value at 4000K CRI 82

12W/1650lm	2W/275lm (Narrow spot)
------------	------------------------

24W/3300lm	6W/825lm (Narrow spot)
------------	------------------------

Light color

	2700K CRI 92 *		3500K CRI 92 *
	3000K CRI 92		4000K CRI 82
	3000K CRI 97 *		4000K CRI 92 *

	2700K CRI 92 *		3500K CRI 92 *
	3000K CRI 92		4000K CRI 82
	3000K CRI 97 *		4000K CRI 92 *

Light distribution

Downlights	Directional luminaires
Extra wide flood	Narrow spot
Lens wallwashers	Spot
Wallwash	Flood

Downlights	Directional luminaires
Extra wide flood	Narrow spot
Lens wallwashers	Spot
Wallwash	Flood

Control

	Trailing edge dimmable
	Switchable **

	Trailing edge dimmable
--	------------------------

Color (housing)

	Silver
--	--------

	Silver
--	--------

Accessories

	Concrete housing
--	------------------



Intercontinental
Resort, Berchtes-
gaden. Architect:
Kochta Architek-
ten, Munich.
Electrical design:
Ingenieurbüro
Schnell, Tuttlin-
gen.

* available on request
** Only for narrow spot light distribution

Article numbers and planning data:
www.erco.com/015746-us

Design and application:
www.erco.com/quintessence-o



