

Lightmark – Precise light of minimalist elegance

The efficient bollard luminaire with good visual comfort for the illumination of pathways and open areas

Lightmark bollard luminaires focus the attention very naturally on any architectural setting. Using the wide light distribution, Lightmark illuminates pathways along walls or buildings evenly over an area wide enough to require a minimum number of luminaires. Their deep-beam version effectively lights squares or terraces.

With their low-maintenance and smooth surface, Lightmark is a robust yet elegant bollard luminaire for the outdoor area. The light

source is discreetly hidden to ensure glare-free light for passers-by. Thanks to Dark Sky technology, Lightmark bollard luminaires emit no spill light above the horizontal plane. The system design of the Lightmark range enables many different combinations of bollard and façade luminaires.





Structure and characteristics

The features described here are typical of products in this range. Special versions may offer additional or varying features. A comprehensive description of the features of individual products can be found on our website.

1 ERCO Spherolit lens

- Light distributions: wide beam or deep beam

2 ERCO LED-module

- High-power LED: warm white (3000K) or neutral white (4000K)
- Collimating lens made of optical polymer

3 Luminaire

- Graphit m
- Corrosion-resistant cast aluminium, No-Rinse surface treatment
- Double powder-coated
- Optimised surface for reduced accumulation of dirt
- Non-reflective safety glass

4 Bollard

- Corrosion-resistant aluminium profile, No-Rinse surface treatment
- Graphit m, double powder-coated
- Tamper-proof screws

5 Control gear

- Switchable

6 Base plate

- For mounting on concrete plinth or accessories

Protection mode IP65

Dust-tight and water jet-proof

Variants on request

- High-power LEDs: 3000K CRI 97 or 2700K, 3500K, 4000K with CRI 92
 - Housing: 10,000 further colours
- Please contact your ERCO consultant.



Design and application:
www.erco.com/lightmark

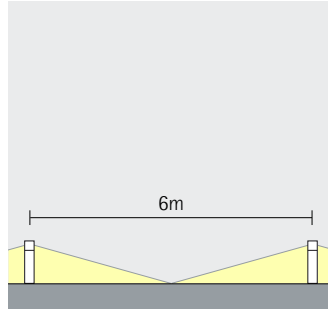

Lightmark Bollard luminaires









Different light distributions: wide or deep
 The wide or deep beam distribution Spherolit lenses allow the light distribution to be matched to the lighting task at hand.

Large luminaire spacing
 ERCO's efficient photometrics enable selected luminaires to be spaced particularly far apart, thereby minimising the number of luminaires required.

Special characteristics

-  Different light distributions: wide or deep
-  Large luminaire spacing possible

-  ERCO high-power LEDs
-  Efficient Spherolit technology
-  Dark Sky technology
-  Different light colours

-  Excellent thermal management
-  EMC-optimised
-  Protection mode IP65

-  Switchable

Lightmark Bollard luminaires – Luminaire arrangement

Floor washlights
Wide beam, Deep beam

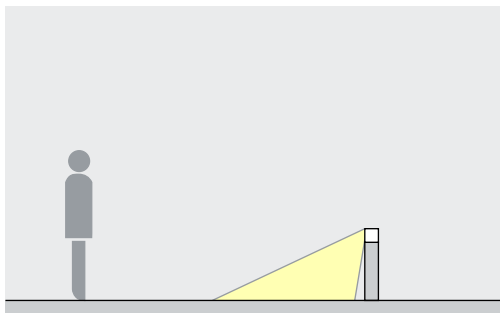

Washlighting
Lightmark bollard luminaires with wide beam light distribution directed forward provide subtle light for a glare-free and uniform illumination of pathways.

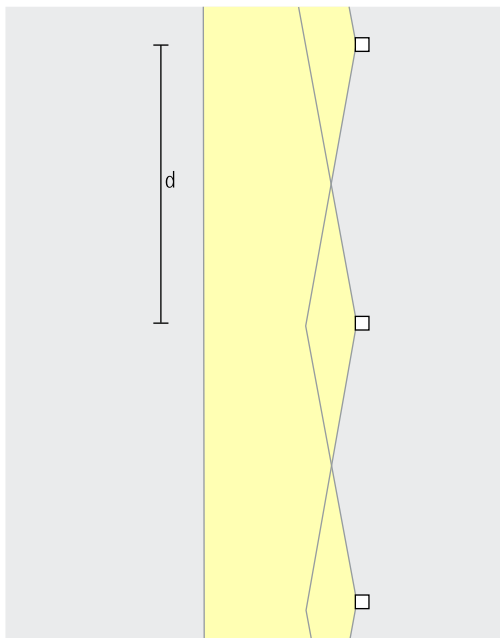

For uniform washlighting of the ground, the luminaire spacing (d) may be up to 3m. The luminaires may be spaced apart even further for visual guidance.

Arrangement: $d \leq 3m$



Lightmark bollard luminaires with deep beam light distribution directed forward provide subtle light for a glare-free and uniform illumination of open areas.

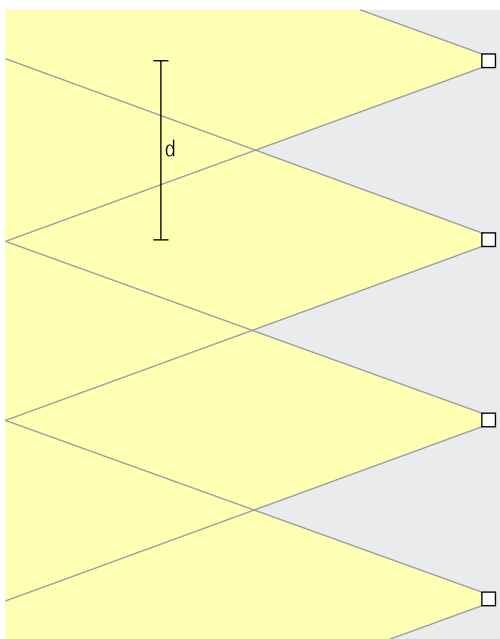

For uniform washlighting of the ground, the luminaire spacing (d) may be up to 3m. The luminaires may be spaced apart even further for visual guidance.

Arrangement: $d \leq 3m$



Eberbach monastery, Eltville.
Architect: Rimpl + Flacht Architekten,
Wiesbaden. Lighting design: Ing.
Bamberger, Pfünz.

Lightmark Bollard luminaires

Construction size 900 mm

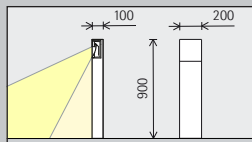

LED module
Maximum value
at 4000K CRI 82

6W/825lm

Light colour

	2700K CRI 92 *		3500K CRI 92 *
	3000K CRI 92		4000K CRI 82
	3000K CRI 97 *		4000K CRI 92 *

Light distribution

Floor washlights	
	Wide beam
	Deep beam

Control

Switchable

Colour (housing)

	Graphit m
	10,000 colours *

Accessories

	Distribution box		Concrete anchor
	Anchorage unit		



* available on request

Article numbers and planning data:
www.erco.com/011960

Design and application:
www.erco.com/lightmark



