



## Quintessence round – The system solution for excellent visual comfort

### **Large luminaire spacing, high uniformity and excellent visual comfort**

Quintessence sets standards in terms of visual comfort, efficiency and quality of light for recessed luminaires. The high-efficiency product family consists of downlights, lens wallwashers and directional spotlights in round and square designs. Characteristic of Quintessence downlights and lens wallwashers is their good glare control and high uniformity of illumination. The 90° beam angle and a 40° cut-off allow wide luminaire spacing between downlights and

therefore high-quality, efficient ambient lighting. Tunable white technology also enables the colour temperature of the light to be modified. Human Centric Lighting concepts are thus supported, matched to the incident daylight.

## Quintessence round Recessed luminaires

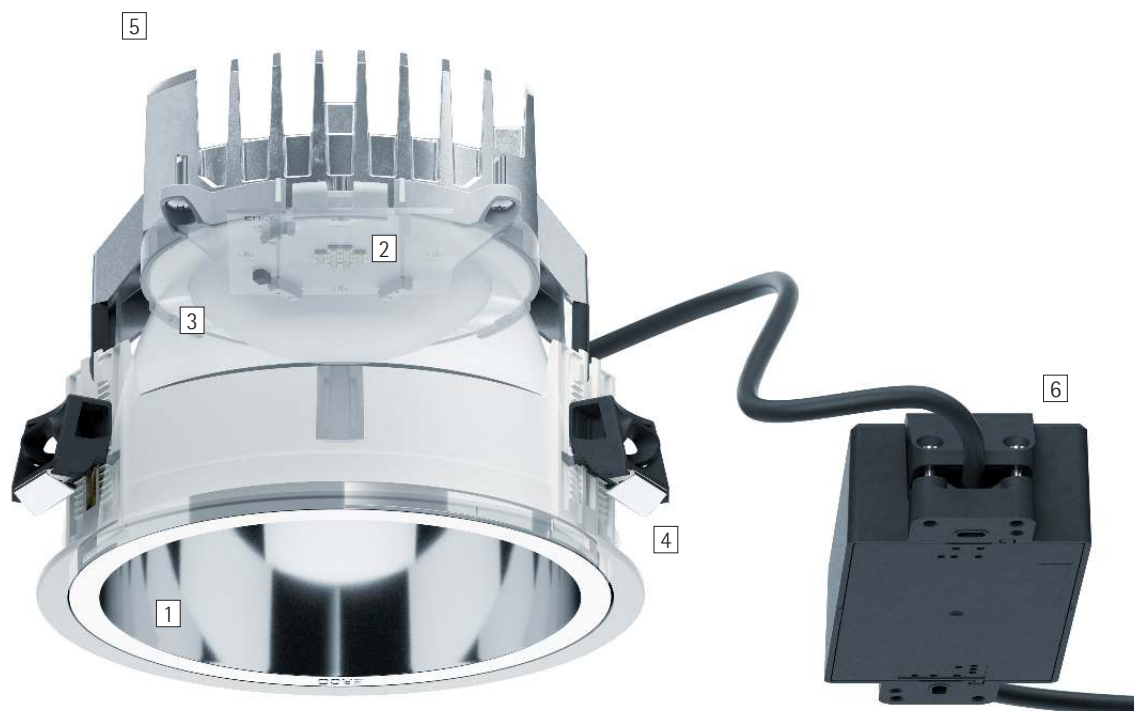

### Structure and characteristics

The features described here are typical of products in this range. Special versions may offer additional or varying features. A comprehensive description of the features of individual products can be found on our website.

#### 1 ERCO darklight reflector

- Downlight: cut-off angle 40°
- Polymer, aluminium vaporised, mirror-finish

or

#### Wallwasher reflector

- Cut-off angle 80°
- Polymer, aluminium vaporised, mirror-finish

#### 2 ERCO LED-module

- High-power LEDs: warm white (2700K or 3000K) or neutral white (3500K or 4000K)
- Chip-on-board LED: tunable white (2700-6500K)
- Directional luminaire with collimating lens made of optical polymer

#### 3 Diffuser or lens

- Made of optical polymer
- Diffuser lens, wide flood, extra wide flood or lens system, wallwash
- Directional luminaire with Spherolit lens narrow spot, spot or flood

#### 4 Mounting ring

- Covered mounting detail
- Fixing for ceiling thicknesses of 1-25mm (size 3-4) or 1-30mm (size 5-7)
- Polymer, white
- For flush mounting: mounting ring to be ordered separately, fixing for ceiling thicknesses of 12.5-25mm

#### 5 Housing

- Cast aluminium, designed as heat sink
- Rotatable through 360°
- Fixing ring: polymer, black
- Fixing of the beam direction
- Directional luminaire: 0°-30° tilt. Lockable angles of tilt and rotation

#### 6 Control gear

- Switchable, phase dimmable, DALI dimmable or Casambi Bluetooth
- Phase dimmable version: Dimming with external dimmers possible (trailing edge)

#### Variants on request

- Reflector: coated matt gold, matt silver or matt champagne
  - Connection: 3- or 5-pole plug with connection cable (Wago or Wieland)
  - Mounting ring: 10,000 further colours
  - Ceiling channel system
- Please contact your ERCO consultant.



Design and application:  
[www.erco.com/quintessence-round](http://www.erco.com/quintessence-round)

# Quintessence round Recessed luminaires



**Very high visual comfort**  
The darklight reflector combines maximum visual comfort with an optimum light output ratio.



**Suitable for office workstations**  
ERCO develops luminaires with the specifications of good glare control and high visual comfort. UGR values are used as support for purely norm-referenced lighting. With downlights though this should not be carried out using 'blanket' values, but should be implemented according to the individual arrangement of luminaires in the room.



**Tunable white technology**  
Just as the colour temperature outdoors changes continuously during the day, the colour temperature of indirect lighting can be adjusted indoors to e.g. support lighting concepts for Human Centric Lighting.



**Covered or flush mounting detail**  
As standard, all recessed luminaires have overlapping installation details. Flush mounting rings are available as accessories.

Special characteristics	
	Excellent visual comfort
	For office workstation lighting from UGR 18.9
	Tunable white
	Flush or covered mounting detail

	ERCO high-power LEDs
	Efficient Spherolit technology
	Cut-off 40°/80°
	Different light distributions
	Different light colours

	Excellent thermal management
	EMC-optimised
	Various construction sizes
	Lockable
	Tool-free mounting

	Switchable
	Phase dimmable
	DALI dimmable
	Casambi Bluetooth

## Quintessence round Recessed luminaires – Luminaire arrangement

### Downlights

Wide flood, Extra wide flood

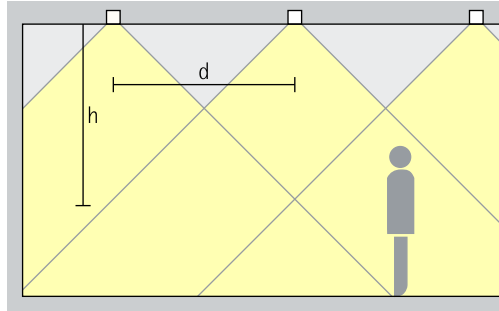

### General lighting

For uniform ambient lighting with high visual comfort, the spacing (d) between two Quintessence downlights may be up to approximately 1.5 times the height (h) of the luminaire above the working plane.

Arrangement:  $d \leq 1.5 \times h$

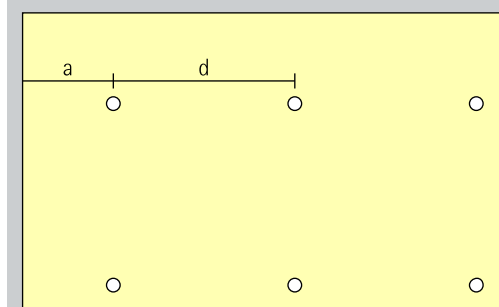

The wall offset should be half the luminaire spacing.

Arrangement:  $a = d / 2$

### Lens wallwashers

Wallwash

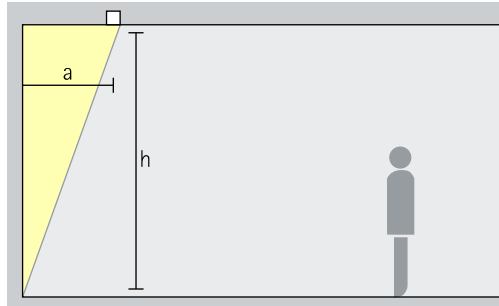

### Wallwashing

For uniform vertical illuminance, the distance (a) of Quintessence lens wallwashers from the wall should be around one third of the room height (h).

Arrangement:  $a = 1/3 \times h$

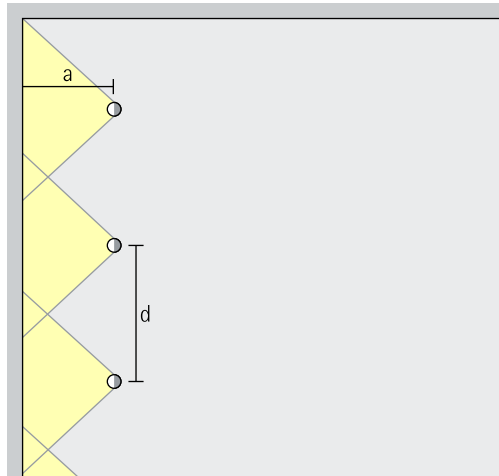

For good longitudinal uniformity, the spacing (d) of Quintessence lens wallwashers may be up to 1.3 times the offset from the wall (a).

Arrangement:  $d \leq 1.3 \times a$

The optimal wall offset and luminaire spacing for each product are indicated in the wallwasher tables in the catalogue and the product data sheets.

### Directional luminaires

Narrow spot, Spot, Flood

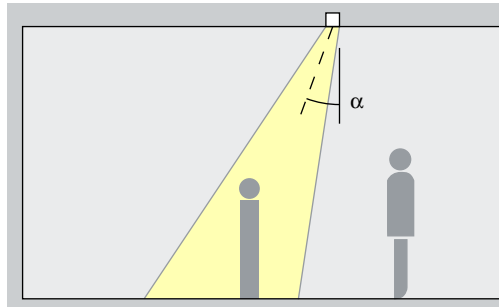

### Accentuation

Quintessence directional luminaires accentuate artwork, products and architectural details effectively. The ideal angle of tilt ( $\alpha$ ) for this is around 30°. The object is modelled without distorting the effect as a result of excessive shadowing. It also prevents shadows cast by the observer.

Arrangement:  $\alpha = 30^\circ$

Central Tower  
Lobby, Guangzhou.  
Lighting design:  
Isometrix Lighting  
Design. Photogra-  
phy: Jackie Chan,  
Sydney.



# Quintessence round Recessed luminaires

Construction size

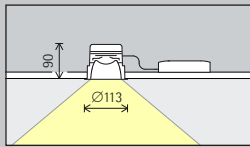

Size 3

LED module  
Maximum value at 4000K CRI 82

12W/1650lm	2W/275lm (Narrow spot)	12W/1600lm
------------	------------------------	------------

Light colour

	2700K CRI 92		3500K CRI 92		Tunable white
	3000K CRI 92		4000K CRI 82		
	3000K CRI 97		4000K CRI 92		

Light distribution

Downlights		Directional luminaires		Downlights	
	Wide flood		Narrow spot		Wide flood
	Extra wide flood		Spot		Extra wide flood
Lens wallwashers			Flood		
	Wallwash				

Control

	Switchable		DALI		DALI
	Phase dimmable		Casambi Bluetooth		

Accessories

	Concrete mounting enclosure		Spacer plate		Compensation set
	Mounting ring		Mounting plate for panelled ceilings		Cover ring

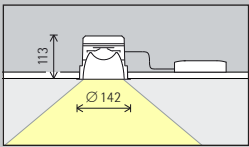

Size 4



\* available on request

Article numbers and planning data:  
[www.erco.com/014091](http://www.erco.com/014091)

Design and application:  
[www.erco.com/quintessence-round](http://www.erco.com/quintessence-round)



# Quintessence round Recessed luminaires

Construction size

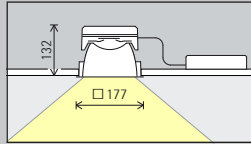

Size 5

LED module  
Maximum value at 4000K CRI 82

24W/3300lm	6W/825lm (Narrow spot)	18W/2400lm
------------	------------------------	------------

Light colour

	2700K CRI 92		3500K CRI 92		Tunable white
	3000K CRI 92		4000K CRI 82		
	3000K CRI 97		4000K CRI 92		

Light distribution

Downlights		Directional luminaires		Downlights	
	Wide flood		Narrow spot		Wide flood
	Extra wide flood		Spot		Extra wide flood
Lens wallwashers			Flood		
	Wallwash				

Control

	Switchable		DALI		DALI
	Phase dimmable		Casambi Bluetooth		

Accessories





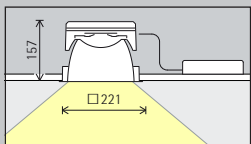

	Concrete mounting enclosure		Spacer plate		Compensation set
	Mounting ring		Mounting plate for panelled ceilings		Cover ring















Size 7

32W/4400lm	8W/1100lm (Narrow spot)
------------	-------------------------

	2700K CRI 92		3500K CRI 92
	3000K CRI 92		4000K CRI 82
	3000K CRI 97		4000K CRI 92

Downlights		Directional luminaires	
	Wide flood		Narrow spot
	Extra wide flood		Spot
Lens wallwashers			Flood
	Wallwash		

	Switchable		DALI
	Phase dimmable		Casambi Bluetooth

\* available on request

Article numbers and planning data:  
[www.erco.com/014091](http://www.erco.com/014091)

Design and application:  
[www.erco.com/quintessence-round](http://www.erco.com/quintessence-round)





University of  
Neubranden-  
burg, Building  
4, Neubranden-  
burg / Germany.  
Architecture:  
A&S GmbH  
Neubranden-  
burg. Lighting  
design: NEIB -  
Neubranden-  
burger Elektro-  
Ingenieur-Büro  
GmbH. Installa-  
tion: EIM GmbH  
Elektro-Install-  
ation-Montage,  
Greifswald. Pho-  
tography: Frieder  
Blickle, Hamburg.

Philharmonic  
Orchestra, Stettin.  
Architecture: Estu-  
dio Barozzi Veiga,  
Barcelona. Photo-  
grapher: Dirk  
Vogel, Dortmund.



