



## ERCO track and singlets – Supporting role

### **ERCO track deliver the energy required to light up rooms**

ERCO track is more than a power source. The system provides a flexible infrastructure for luminaires, that can move with your changing requirements. Track are the anchor for your lighting concept and are primarily designed for mounting on ceilings or walls, whereas the flanged track is designed for suspended ceilings. Individual track lengths can be connected with each other so as to form rectangular and other shapes.



## Structure and characteristics

The features described here are typical of products in this range. Special versions may offer additional or varying features. A comprehensive description of the features of individual products can be found on our website.

### 1 Aluminum profile

- White (RAL9002), black or silver
- Powder-coated or anodized
- Track mounting surface with easy to remove knockouts at 15 3/4" (0.4m) intervals
- Flanged track: flanges for ceiling panels

### 2 Contacts

- 4 isolated copper conductors
- 2 separately switchable circuits of 20A each

### 3 Earth conductor

#### Variants on request

- Housing: 10,000 further colors
- Please contact your ERCO consultant.



Design and application:  
[www.erco.com/erco-track](http://www.erco.com/erco-track)

# ERCO track and singlets

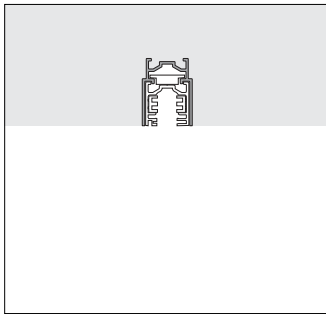

**Recessed**  
A plaster trim profile is available as an accessory for flush mounting in the ceiling or wall.

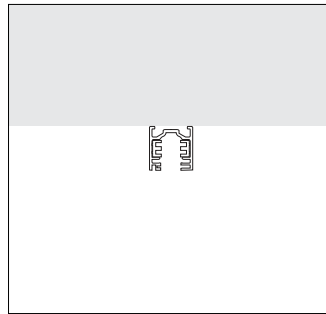

**Surface-mounted**  
Track can be easily mounted to ceilings and walls as a surface-mounted variant.

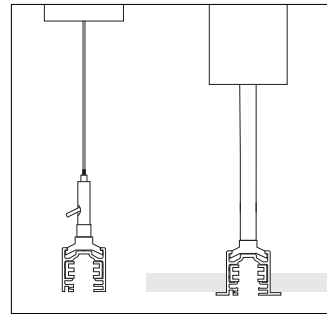

**Suspensions**  
Track can be simply suspended from the ceiling. Wire suspensions are ideal for sloping ceilings and pendant tubes are suitable for high loads.



**Gap-free mounting using connection components**  
The track and light structures can be connected to form straight lines with gap-free couplings or assembled to make right-angled structures with connecting parts.

Special characteristics	
	Recessed
	Surface-mounted
	Suspensions
	Continuous line arrangements are possible

- Various housing colors
- Various construction sizes
- Easy installation
- Accessory for mounting variants

# ERCO 2-circuit track and singlets

## ERCO 2-circuit track

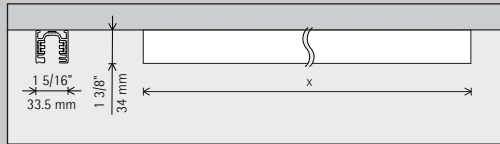

### Type of mounting

	Surface-mounted
	Recessed (via accessories)
	Pendant (via accessories)

### Length

4ft	12ft
8ft	Special length *

### Application

2-circuit ✓ Switchable ✓ Phase dimmable ✓ Casambi Bluetooth
--

### Color (housing)

	White		Silver
	Black		10,000 colors *

## ERCO 2-circuit flanged track

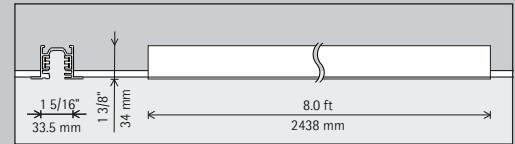

	Recessed
	Pendant (via accessories)

8ft
Special length *

2-circuit ✓ Switchable ✓ Phase dimmable ✓ Casambi Bluetooth
--

	White		Silver
	Black		10,000 colors *



### Accessories

	Connection components		Suspension equipment
	Turning adapter		Mounting components

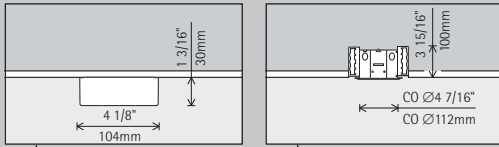
# ERCO 1-circuit singlet



1-circuit  
✓ Switchable  
✓ Phase dimmable  
✓ Casambi Bluetooth

	White		10,000 colors *
	Black		

\* available on request

Article numbers and planning data:  
[www.erco.com/011280-us](http://www.erco.com/011280-us)

Design and application:  
[www.erco.com/erco-track](http://www.erco.com/erco-track)





Irish Museum  
of Modern  
Art(IMMA), Dublin.  
Photography: Dirk  
Vogel, Altena.

Franconian Gallery  
Kronach. Lighting  
design: licht-  
transfer, Katrin  
Söncksen, Berlin.  
Photographer:  
Alexandra Lechner,  
Frankfurt.

