

Lightmark – Precise light of minimalist elegance

The efficient bollard luminaire with good visual comfort for the illumination of pathways and open areas

Lightmark bollard luminaires focus the attention very naturally on any architectural setting. Using the wide light distribution, Lightmark illuminates pathways along walls or buildings evenly over an area wide enough to require a minimum number of luminaires. Their deep-beam version effectively lights squares or terraces.

With their low-maintenance and smooth surface, Lightmark is a robust yet elegant bollard luminaire for the outdoor area. The

light source is discreetly hidden to ensure glare-free light for passers-by. Thanks to dark sky technology, Lightmark bollard luminaires emit no spill light above the horizontal plane. The system design of the Lightmark range enables many different combinations of bollard and façade luminaires.

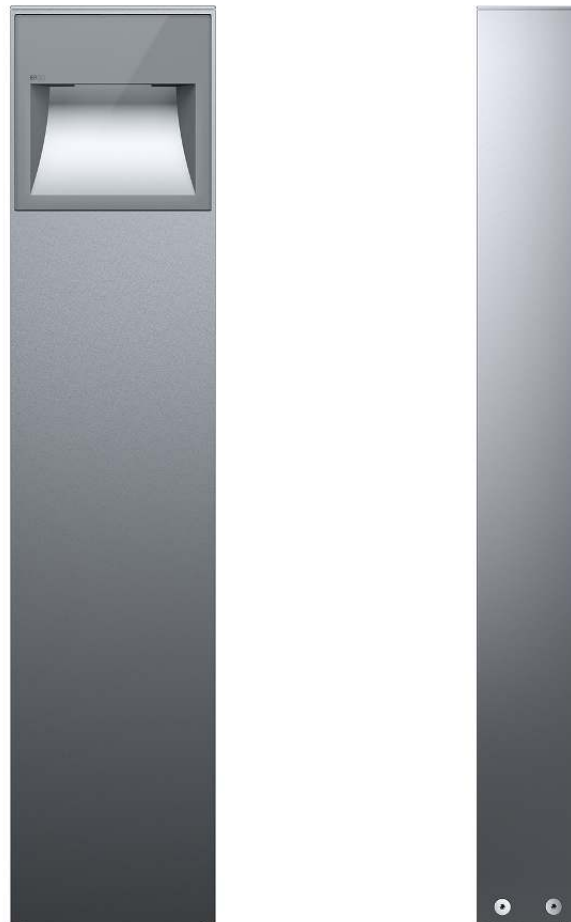

Structure and characteristics

The features described here are typical of products in this range. Special versions may offer additional or varying features. A comprehensive description of the features of individual products can be found on our website.



1 ERCO Spherolit lens

- Light distributions: wide beam or deep beam

2 ERCO LED-module

- High-power LEDs: warm white (3000K) or neutral white (4000K)
- Collimating lens made of optical polymer

3 Luminaire

- Graphit m
- Corrosion-resistant cast aluminum, No-Rinse surface treatment
- Double powder-coated
- Optimized surface for reduced accumulation of dirt
- Non-reflective safety glass

4 Bollard

- Corrosion-resistant aluminum profile, No-Rinse surface treatment
- Graphit m, double powder-coated
- Tamper-proof screws

5 Control gear

- Trailing edge dimmable
- Operation at 120V: Dimming with external dimmers possible
- Operation at 277V: switchable

6 Base plate

- For mounting on concrete plinth or accessories

Suitable for wet locations (IP65)

Dust-proof and water jet-proof

Variants on request

- High-power LEDs: 3000K CRI 97 or 2700K, 3500K, 4000K with CRI 92
 - Housing: 10,000 further colors
- Please contact your ERCO consultant.



Design and application:
www.erco.com/lightmark

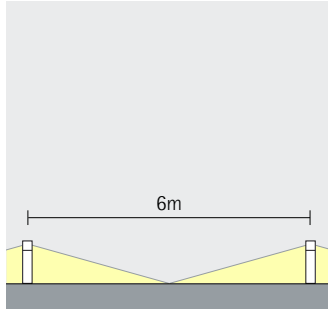

Lightmark Bollard luminaires



Different light distributions: wide or deep
 The wide or deep beam distribution Spherolit lenses allow the light distribution to be matched to the lighting task at hand.

Large luminaire spacing
 ERCO's efficient photometrics enable selected luminaires to be spaced particularly far apart, thereby minimizing the number of luminaires required.

Special characteristics

-  Different light distributions: wide or deep
-  Large luminaire spacing possible



ERCO high-power LEDs



Efficient Spherolit technology



Dark Sky technology



Different light colors



Excellent thermal management



EMC-optimized



Wet location



Trailing edge dimmable

Lightmark Bollard luminaires – Luminaire arrangement

Floor washlights
Wide beam, Deep beam

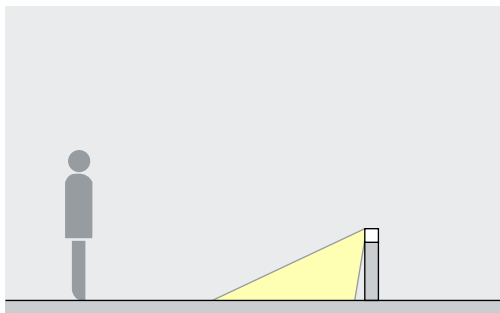

Washlighting
Lightmark bollard luminaires with wide beam light distribution directed forward provide subtle light for a glare-free and uniform illumination of pathways.

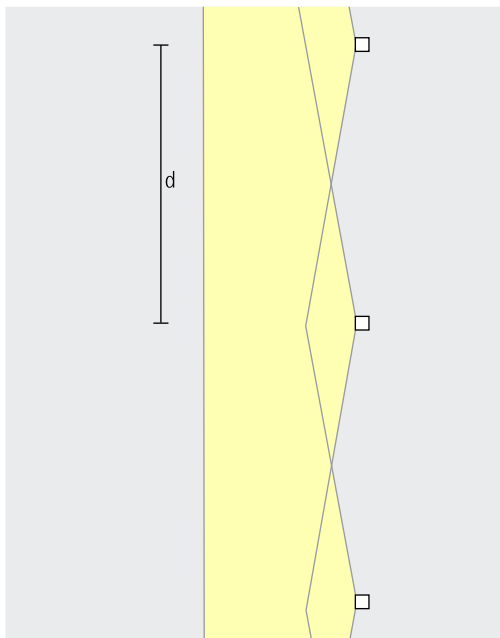

For uniform washlighting of the ground, the luminaire spacing (d) may be up to 9ft. The luminaires may be spaced apart even further for visual guidance.

Arrangement: $d \leq 9\text{ft}$

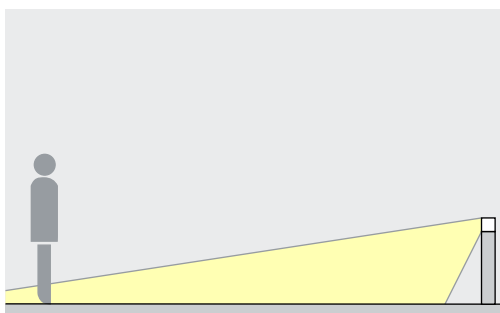

Lightmark bollard luminaires with deep beam light distribution directed forward provide subtle light for a glare-free and uniform illumination of open areas.

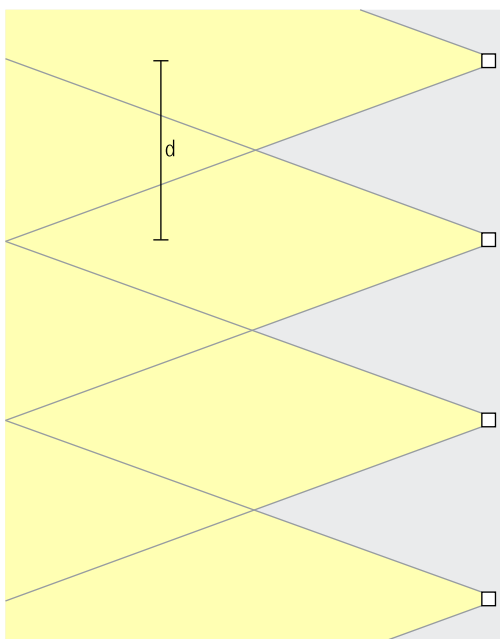

For uniform washlighting of the ground, the luminaire spacing (d) may be up to 9ft. The luminaires may be spaced apart even further for visual guidance.

Arrangement: $d \leq 9\text{ft}$



Lightmark Bollard luminaires

Construction size 35 7/16"

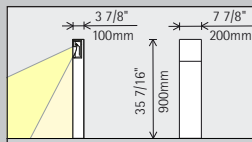

LED module
Maximum value
at 4000K CRI 82

6W/825lm

Light color

	2700K CRI 92 *		3500K CRI 92 *
	3000K CRI 92		4000K CRI 82
	3000K CRI 97 *		4000K CRI 92 *

Light distribution

	Floor washlights
	Wide beam
	Deep beam

Control

Trailing edge dimmable

Color (housing)

	Graphit m
	10,000 colors *

Accessories

	Ground socket		Mounting plate
	Concrete anchor		



* available on request

Article numbers and planning data:
www.erco.com/011960-us

Design and application:
www.erco.com/lightmark



