



Quintessence round – The system solution for excellent visual comfort

High visual comfort and optimum light quality – in indoor and outdoor areas

Quintessence recessed downlights bring the visual comfort and quality of light of downlights, lens wallwashers and directional spotlights to outdoor spaces. The downlights and lens wallwashers achieve a high level of uniformity with good glare control and are perfect for illuminating wide areas. The extremely wide distribution of the downlights with 90° beam angle and 40° cut-off enables large luminaire spacings. For precise accents, the optic of the directional

spotlights can be tilted by 20° and rotated through 360°. IP65 protection makes Quintessence recessed downlights the ideal tool for canopied outdoor spaces.

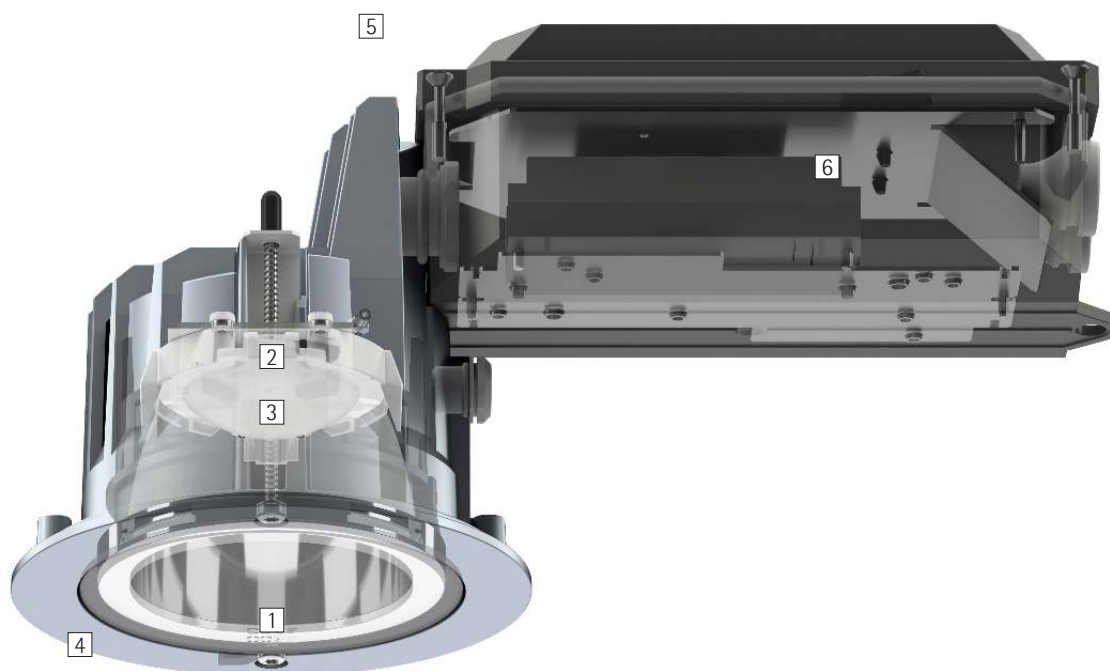

Structure and characteristics

The features described here are typical of products in this range. Special versions may offer additional or varying features. A comprehensive description of the features of individual products can be found on our website.

1 ERCO darklight reflector

- Downlight: cut-off angle 40°
- Polymer, aluminium vaporised, mirror-finish

or

Wallwasher reflector

- Cut-off angle 80°
- Polymer, aluminium vaporised, mirror-finish

2 ERCO LED-module

- High-power LEDs: warm white (3000K) or neutral white (4000K)
- Directional luminaire with collimating lens made of optical polymer: 0°-20° tilt, 360° rotation

3 Diffuser or lens

- Made of optical polymer
- Diffuser lens, extra wide flood or lens system, wallwash
- Directional luminaire with Spherolit lens narrow spot, spot or flood

4 Cover ring

- Corrosion-resistant cast aluminium, No-Rinse surface treatment
- Silver, double powder-coated
- Safety glass

5 Housing

- Cast aluminium, powder-coated silver
- Mounting with 2- or 3-point contact and screw fastening, for ceiling thicknesses 1-30mm
- Side-attached installation unit: polymer, black

6 Control gear

- Switchable or DALI dimmable

Protection mode IP65

Dust-tight and water jet-proof

Variants on request

- High-power LEDs: 3000K CRI 97 or 2700K, 3500K, 4000K with CRI 92
 - Reflector: coated matt gold, matt silver or matt champagne
- Please contact your ERCO consultant.



Design and application:
www.erco.com/quintessence-o

Quintessence round Recessed luminaires

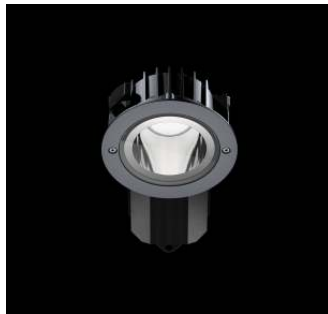

Very high visual comfort

The darklight reflector combines maximum visual comfort with an optimum light output ratio.

Special characteristics



Excellent visual comfort



ERCO high-power LEDs



Excellent thermal management



Switchable



Cut-off 40°/80°



EMC-optimised



DALI dimmable



Different light distributions



Various construction sizes



Different light colours



Protection mode IP65

Quintessence round Recessed luminaires – Luminaire arrangement

Downlights Extra wide flood

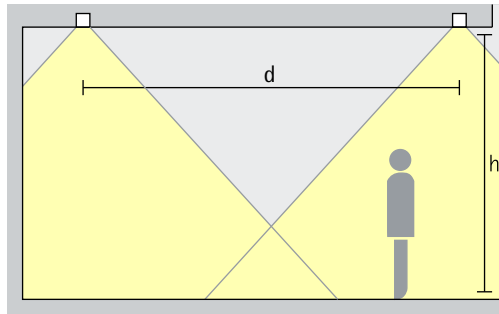

General lighting
For uniform ambient lighting, the spacing (d) between two Quintessence downlights may be up to approximately 1.5 times the height (h) of the luminaire above the working plane.

Arrangement: $d \leq 1.5 \times h$

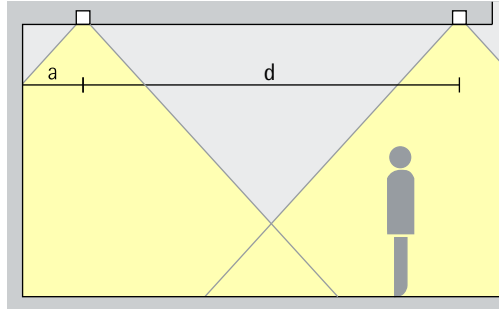

The wall offset should be half the luminaire spacing.

Arrangement: $a = d / 2$

Lens wallwashers Wallwash

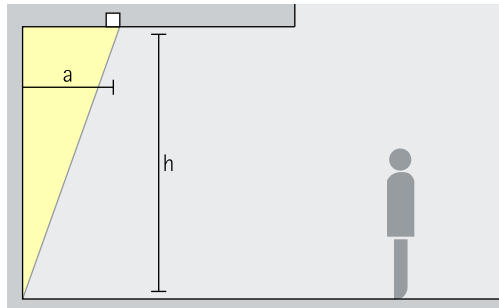

Wallwashing
For uniform vertical illuminance, the distance (a) of Quintessence lens wallwashers from the wall should be around one third of the room height (h).

Arrangement: $a = 1/3 \times h$

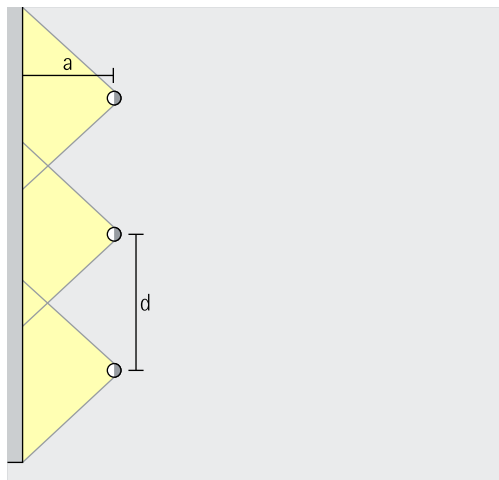

For good longitudinal uniformity, the spacing (d) of Quintessence lens wallwashers may be up to 1.3 times the offset from the wall (a).

Arrangement: $d \leq 1.3 \times a$

The optimal wall offset and luminaire spacing for each product are indicated in the wallwasher tables in the catalogue and the product data sheets.

Directional luminaires Narrow spot, Spot, Flood

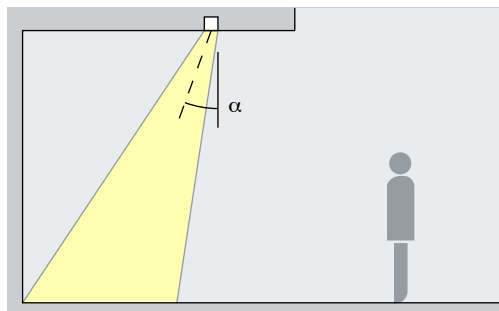

Accentuation
Quintessence directional luminaires accentuate artwork, products and architectural details effectively. The ideal angle of tilt (α) for this is around 20° . The object is modelled without distorting the effect as a result of excessive shadowing. It also prevents shadows cast by the observer.

Arrangement: $\alpha = 20^\circ$

Sheikh Zayed bin Sultan Al Nahyan Mosque, Abu Dhabi. Architect: Yusef Abdelki (design), Halcrow, Dubai Office (implementation). Interior design: Spatium Architects, Milan. Lighting design: Speirs and Major Associates, Edinburgh.



Quintessence Recessed luminaires

Construction size

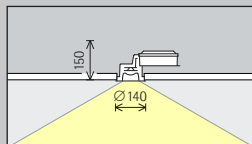

Size 3

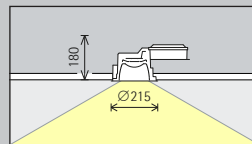

Size 5

LED module
Maximum value at 4000K CRI 82

12W/1650lm	2W/275lm (Narrow spot)
------------	------------------------

24W/3300lm	6W/825lm (Narrow spot)
------------	------------------------

Light colour

	2700K CRI 92 *		3500K CRI 92 *
	3000K CRI 92		4000K CRI 82
	3000K CRI 97 *		4000K CRI 92 *

	2700K CRI 92 *		3500K CRI 92 *
	3000K CRI 92		4000K CRI 82
	3000K CRI 97 *		4000K CRI 92 *

Light distribution

Downlights	Directional luminaires
Extra wide flood	Narrow spot
Lens wallwashers	Spot
Wallwash	Flood

Downlights	Directional luminaires
Extra wide flood	Narrow spot
Lens wallwashers	Spot
Wallwash	Flood

Control

	Switchable
	DALI

	Switchable
	DALI

Colour (housing)

	Silver
--	--------

	Silver
--	--------

Accessories

	Concrete mounting enclosure
--	-----------------------------



Intercontinental
Resort, Berchtes-
gaden. Architect:
Kochta Architek-
ten, Munich. Elec-
trical design:
Ingenieurbüro
Schnell, Tuttlin-
gen.

* available on request

Article numbers and planning data:
www.erco.com/015746

Design and application:
www.erco.com/quintessence-o



