

# Lightmark – Precise light of minimalist elegance

**The efficient bollard luminaire with good visual comfort for the illumination of pathways and open areas**

Lightmark, with its wide light distribution, illuminates paths alongside walls or buildings with high uniformity and over a large area so that only a minimum number of luminaires is required. The narrow light distribution is ideal for illuminating squares or terraces. The easy-care glass surface makes Lightmark a robust and at the same time elegant bollard luminaire for outdoor applications. The light source remains discreetly concealed so that passers-by are not

subjected to glare. Thanks to Dark Sky technology, Lightmark bollard luminaires emit no spill light above the horizontal plane.

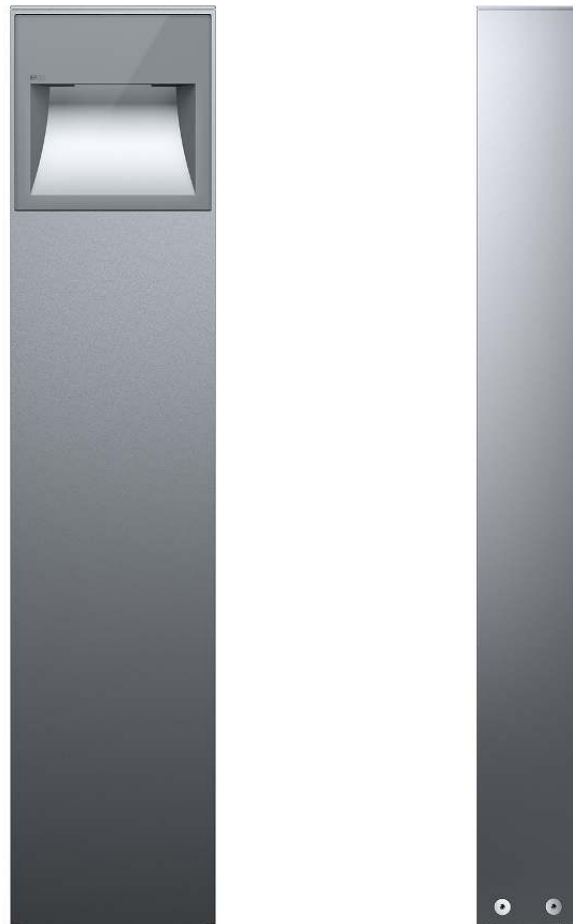



## Structure and characteristics

The features described here are typical of products in this range. Special versions may offer additional or varying features. A comprehensive description of the features of individual products can be found on our website.

### 1 ERCO Spherolit lens

- Light distributions: wide beam or deep beam

### 2 ERCO LED-module

- High-power LED: warm white (3000K) or neutral white (4000K)
- Collimating lens made of optical polymer

### 3 Luminaire

- Graphit m
- Corrosion-resistant cast aluminium, No-Rinse surface treatment
- Double powder-coated
- Optimised surface for reduced accumulation of dirt
- Non-reflective safety glass

### 4 Bollard

- Corrosion-resistant aluminium profile, No-Rinse surface treatment
- Graphit m, double powder-coated
- Tamper-proof screws

### 5 Control gear

- Switchable

### 6 Base plate

- For mounting on concrete plinth or accessories

### Protection mode IP65

Dust-tight and water jet-proof

### Variants on request

- High-power LEDs: 3000K CRI 97 or 2700K, 3500K, 4000K with CRI 92
  - Housing: 10,000 further colours
- Please contact your ERCO consultant.



Design and application:  
[www.erco.com/lightmark](http://www.erco.com/lightmark)

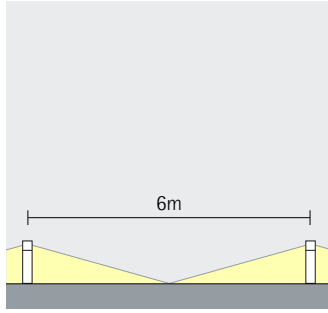

# Lightmark Bollard luminaires



**Different light distributions: wide or deep**  
 The wide or deep beam distribution Spherolit lenses allow the light distribution to be matched to the lighting task at hand.

**Large luminaire spacing**  
 ERCO's efficient photometrics enable selected luminaires to be spaced particularly far apart, thereby minimising the number of luminaires required.

**Special characteristics**

-  Different light distributions: wide or deep
-  Large luminaire spacing possible



ERCO high-power LEDs



Efficient Spherolit technology



Dark Sky technology



Different light colours



Excellent thermal management



EMC-optimised



Protection mode IP65



Switchable

# Lightmark Bollard luminaires – Luminaire arrangement

Floor washlights  
Wide beam, Deep beam

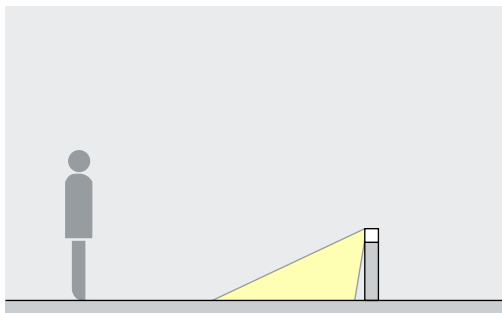

**Washlighting**  
Lightmark bollard luminaires with wide beam light distribution directed forward provide subtle light for a glare-free and uniform illumination of pathways.

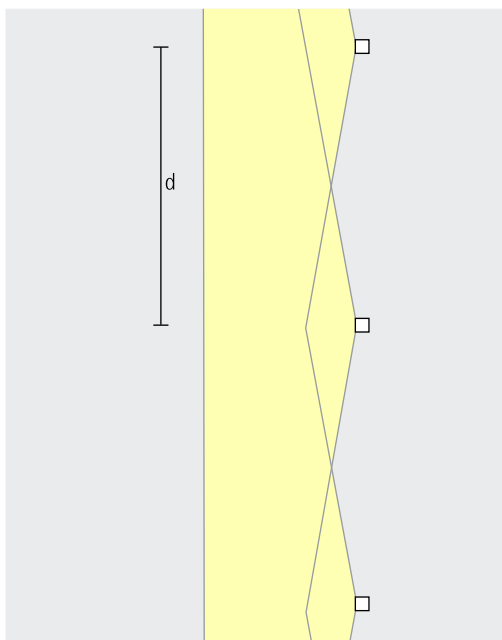

For uniform washlighting of the ground, the luminaire spacing ( $d$ ) may be up to 3m. The luminaires may be spaced apart even further for visual guidance.

Arrangement:  $d \leq 3m$



Lightmark bollard luminaires with deep beam light distribution directed forward provide subtle light for a glare-free and uniform illumination of open areas.

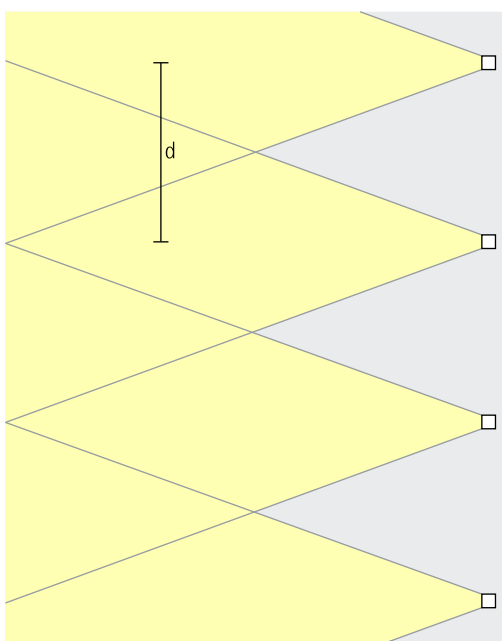

For uniform washlighting of the ground, the luminaire spacing ( $d$ ) may be up to 3m. The luminaires may be spaced apart even further for visual guidance.

Arrangement:  $d \leq 3m$



Eberbach monastery, Eltville.  
Architect: Rimpl + Flacht Architekten,  
Wiesbaden. Lighting design: Ing.  
Bamberger, Pfünz.

# Lightmark Bollard luminaires

Construction size 900 mm

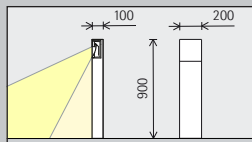

LED module  
Maximum value  
at 4000K CRI 82

6W/825lm

Light colour

|  |                |  |                |
|--|----------------|--|----------------|
|  | 2700K CRI 92 * |  | 3500K CRI 92 * |
|  | 3000K CRI 92   |  | 4000K CRI 82   |
|  | 3000K CRI 97 * |  | 4000K CRI 92 * |

Light distribution

|                  |           |
|------------------|-----------|
| Floor washlights |           |
|                  | Wide beam |
|                  | Deep beam |

Control

Switchable

Colour (housing)

|  |                  |
|--|------------------|
|  | Graphit m        |
|  | 10,000 colours * |

Accessories

|  |                  |  |                 |
|--|------------------|--|-----------------|
|  | Distribution box |  | Concrete anchor |
|  | Anchorage unit   |  |                 |



\* available on request

Article numbers and planning data:  
[www.erco.com/011960](http://www.erco.com/011960)

Design and application:  
[www.erco.com/lightmark](http://www.erco.com/lightmark)



