

# Beamer – Maximum visual comfort for superior standards

## **Efficient outdoor accentuation and floodlighting in a classic design**

Beamer achieves impressive displays of monuments, buildings and vegetation. Protected by an extremely durable housing, the projector allows you to implement nuanced solutions for your lighting tasks. The excellent glare control by the snoot guarantees a high level of visual comfort and ensures that light only reaches where it is needed. The mounting accessories ensure that Beamer can be installed precisely where it is needed. You can always set up the luminaire in a reproducible way

thanks to the scale attached to the hinge. The maintenance-free optoelectronics of Beamer protect our resources thanks to its high efficiency, and thus reduce operating costs.



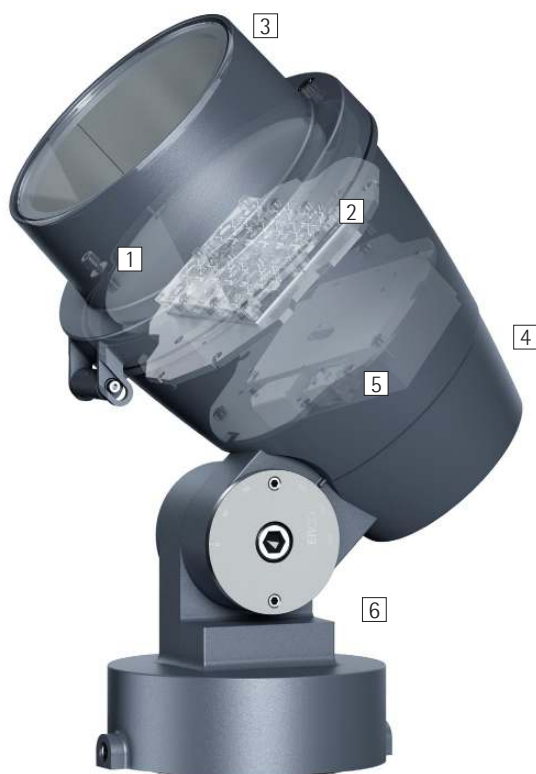

## Structure and characteristics

The features described here are typical of products in this range. Special versions may offer additional or varying features. A comprehensive description of the features of individual products can be found on our website.

### 1 ERCO Spherolit lens

- Light distributions: narrow spot, spot, flood, wide flood, extra wide flood or oval flood
- Oval flood 360° rotation

### 2 ERCO LED-module

- High-power LEDs: warm white (3000K) or neutral white (4000K)
- Collimating lens made of optical polymer

### 3 Snoot

- Corrosion-resistant cast aluminum, No-Rinse surface treatment
- Graphit m, double powder-coated
- Without stray light
- Safety glass

### 4 Housing

- Graphit m
- Corrosion-resistant cast aluminum, No-Rinse surface treatment
- Double powder-coated
- Optimized surface for reduced accumulation of dirt

### 5 Control gear

- Switchable or trailing edge dimmable
- Trailing edge dimmable version:**
- Operation at 120V: Dimming with external dimmers possible
- Operation at 277V: switchable

### 6 Mounting plate and hinge

- Corrosion-resistant cast aluminum, No-Rinse surface treatment
- Graphit m, double powder-coated
- Mounting plate: rotatable through 300°
- Hinge: 130° tilt
- Internal wiring
- Dial: corrosion-resistant aluminum

### Suitable for wet locations (IP65)

Dust-proof and water jet-proof

### Variants on request

- High-power LEDs: 3000K CRI 97 or 2700K, 3500K, 4000K with CRI 92
  - Housing: 10,000 further colors
- Please contact your ERCO consultant.



Design and application:  
[www.erco.com/beamer](http://www.erco.com/beamer)

# Beamer Projectors, floodlights



**Oval flood freely rotatable**  
The oval flood Spherolit lens can be freely rotated with round luminaire heads to optimally match the lighting to various objects.



**Various construction sizes**  
The luminaires in the ERCO product range cover a wide variety of lumen categories and therefore offer an appropriate solution for a large number of lighting tasks.



**Lockable**  
To ensure continuously fixed alignment of the light beam, the alignment can be securely locked.

**Special characteristics**

- Oval flood, freely rotatable
- Various construction sizes
- Lockable

- ERCO high-power LEDs
- Efficient Spherolit technology
- Different light distributions
- Different light colors

- Excellent thermal management
- EMC-optimized
- Degree scale for good adjustability
- Pivotal through 130°
- Wet location
- Accessory for mounting variants

- Switchable
- Trailing edge dimmable

## Beamer Projectors, floodlights – Luminaire arrangement

### Projectors

Narrow spot, Spot, Flood

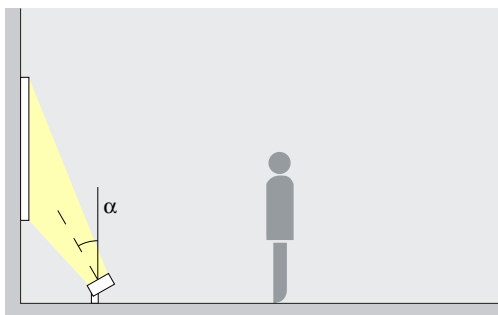

### Accentuation

The ideal angle of tilt ( $\alpha$ ) for accent lighting with Beamer projectors is around  $30^\circ$ . This emphasises the three-dimensionality of architectural details, sculptures or trees, without distorting the spatial impression with excessive shadowing.

Arrangement:  $\alpha = 30^\circ$

### Floodlights

Wide flood, Extra wide flood, Oval flood

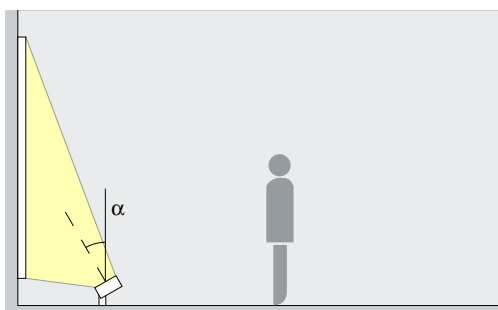

### Washlighting

Beamer projectors ensure uniform floodlighting of long wall surfaces, columns or trees. The ideal angle of tilt ( $\alpha$ ) for this is around  $30^\circ$

Arrangement:  $\alpha = 30^\circ$



The Hard Interchange, Portsmouth. Architecture: AHR Architects, London. Lighting design: Lachman Consulting of Leeds. Photography: Lukas Palik, Düsseldorf.

German Pavilion  
"Fields of Ideas" at  
the EXPO 2015,  
Milan. Concept:  
Arbeitsgemein-  
schaft Deutscher  
Pavillon GbR;  
Milla Et Part-  
ner, Stuttgart;  
Schmidhuber,  
Munich; Nüssli  
GmbH, Roth. Exhi-  
bition design:  
Milla Et Partner.  
Architecture:  
Schmidhuber;  
Nüssli. Photogra-  
phy: Dirk Vogel,  
Dortmund.



Theaterplein,  
Antwerp. Archi-  
tect: Studio  
Bernardo Secchi  
& Paola Vigano,  
Milan.

# Beamer Projectors, floodlights

## Construction size

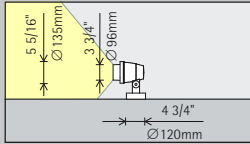

Ø 5 5/16"

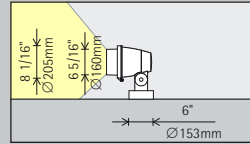

Ø 8 1/16"

## LED module

Maximum value at 4000K CRI 82

12W/1650lm	4W/550lm (Narrow spot)
------------	------------------------

36W/4950lm	14W/1925lm (Narrow spot)
------------	--------------------------

## Light color

	2700K CRI 92 *		3500K CRI 92 *
	3000K CRI 92		4000K CRI 82
	3000K CRI 97 *		4000K CRI 92 *

	2700K CRI 92 *		3500K CRI 92 *
	3000K CRI 92		4000K CRI 82
	3000K CRI 97 *		4000K CRI 92 *

## Light distribution

Projectors		Floodlights	
	Narrow spot		Wide flood
	Spot		Extra wide flood
	Flood		Oval flood

Projectors		Floodlights	
	Narrow spot		Wide flood
	Spot		Extra wide flood
	Flood		Oval flood

## Control

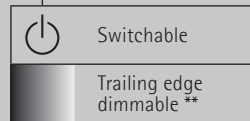
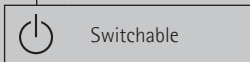

## Color (housing)

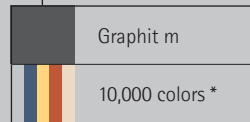
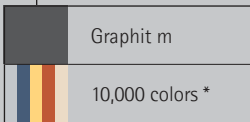

## Accessories

	Ground socket		Attachment
	Concrete anchor		Clamping plate
	Mounting plate		Spacer
	Cantilever arm		

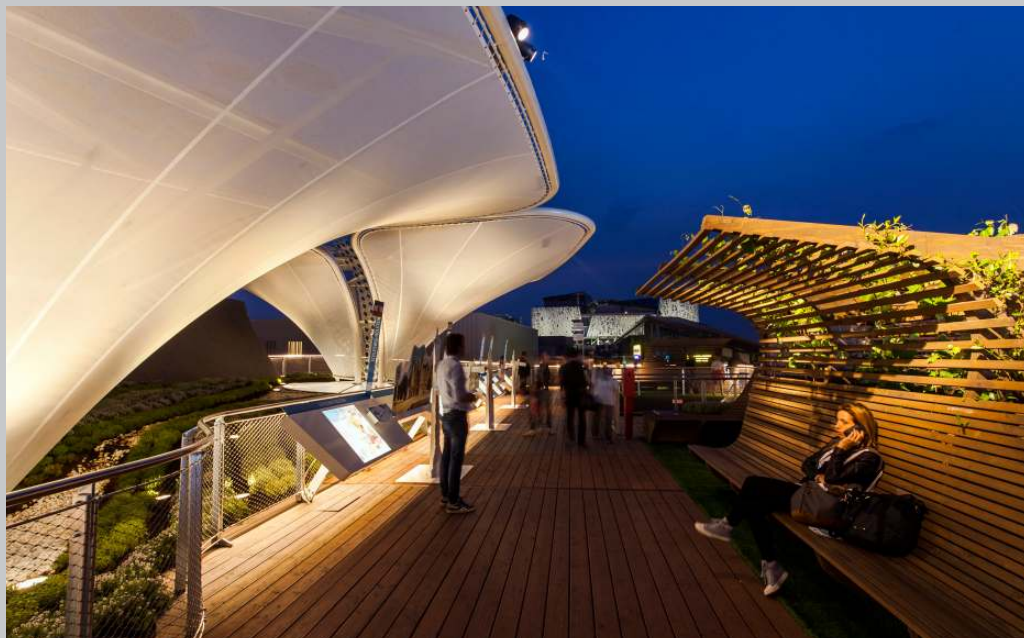

German Pavilion,  
„Fields of  
Ideas“, Expo, Milan.  
Architecture:  
Schmidhuber,  
Munich / Milla &  
Partner, Stuttgart.  
Photography:  
Dirk Vogel, Altena.

\* available on request  
\*\* Only for narrow spot light distribution

Article numbers and planning data:  
[www.erco.com/011752-us](http://www.erco.com/011752-us)

Design and application:  
[www.erco.com/beamer](http://www.erco.com/beamer)



