

## Quintessence – The system solution for excellent visual comfort

### **High visual comfort and optimum light quality – in indoor and outdoor areas**

Quintessence recessed downlights bring the visual comfort and quality of light of downlights, lens wallwashers and directional spotlights to outdoor spaces. The downlights and lens wallwashers achieve a high level of uniformity with good glare control and are perfect for illuminating wide areas. The extremely wide distribution of the downlights with 90° beam angle and 40° shielding angle enables large luminaire spacings. For precise accents, the optic of the

directional spotlights can be tilted by 20° and rotated through 360°. IP65 protection makes Quintessence recessed downlights the ideal tool for canopied outdoor spaces.

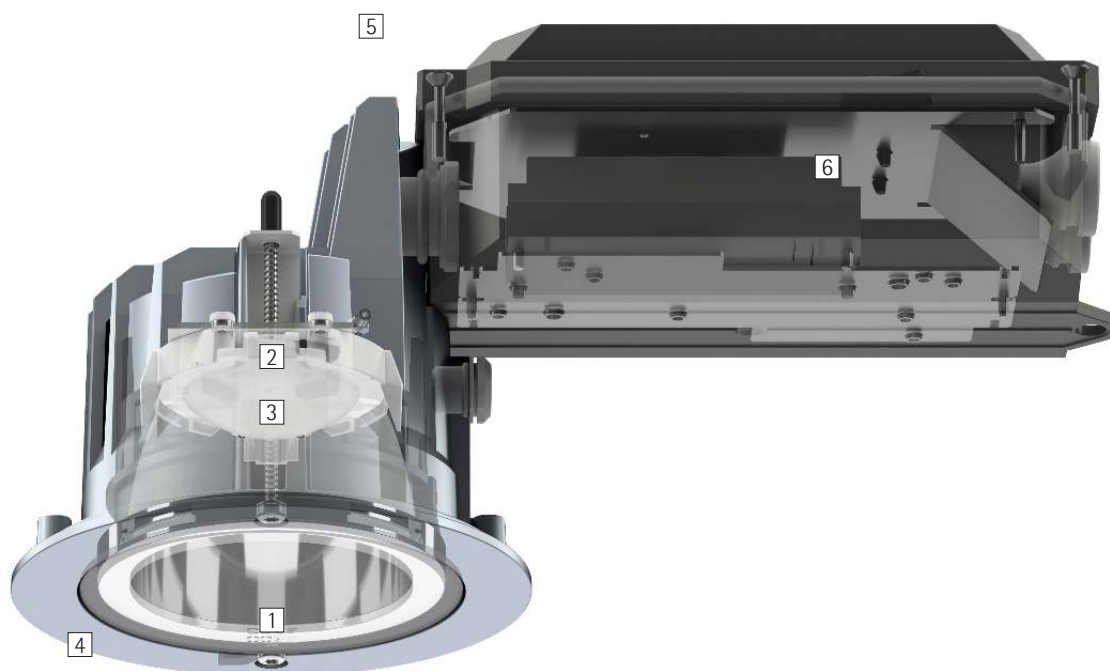

## Structure and characteristics

The features described here are typical of products in this range. Special versions may offer additional or varying features. A comprehensive description of the features of individual products can be found on our website.

### 1 ERCO low brightness reflector

- Downlight: cut-off angle 40° from horizontal
- Polymer, aluminum vaporized, specular

or

### Wallwasher reflector

- Cut-off angle 80° from horizontal
- Polymer, aluminum vaporized, specular

### 2 ERCO LED-module

- High-power LEDs: warm white (3000K) or neutral white (4000K)
- Directional luminaire with collimating lens made of optical polymer: 0°-20° tilt, 360° rotation

### 3 Diffuser or lens

- Made of optical polymer
- Diffuser lens, extra wide flood or lens system, wallwash
- Directional luminaire with Spherolit lens narrow spot, spot or flood

### 4 Cover ring

- Corrosion-resistant cast aluminum, No-Rinse surface treatment
- Silver, double powder-coated
- Safety glass

### 5 Housing

- Cast aluminum, powder-coated silver
- Mounting with 2- or 3-point contact and screw fastening. Max. ceiling thickness 1 3/16"
- Side-attached installation unit: polymer, black

### 6 Control gear

- Trailing edge dimmable
- Operation at 120V: Dimming with external dimmers possible
- Operation at 277V: switchable

### Suitable for wet locations (IP65)

Dust-proof and water jet-proof

### Variants on request

- High-power LEDs: 3000K CRI 97 or 2700K, 3500K, 4000K with CRI 92
  - Reflector: coated matt gold, matt silver or matt champagne
- Please contact your ERCO consultant.



Design and application:  
[www.erco.com/quintessence-o](http://www.erco.com/quintessence-o)

# Quintessence Recessed luminaires



**Very high visual comfort**  
 The low brightness reflector combines maximum visual comfort with an optimum light output ratio.

## Special characteristics

 Excellent visual comfort



ERCO high-power LEDs



Excellent thermal management



Switchable



Cut-off 40°/80° from horizontal



EMC-optimized



Trailing edge dimmable



Different light distributions



Various construction sizes



Different light colors



Wet location

# Quintessence Recessed luminaires – Luminaire arrangement

**Richtstrahler**  
Narrow spot, Spot, Flood

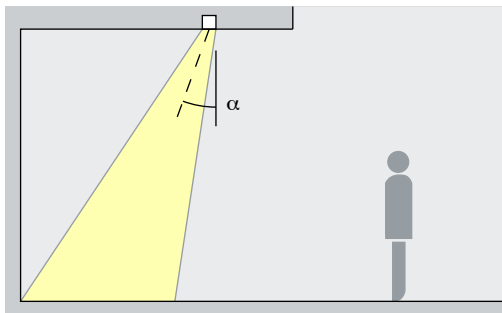

**Accentuation**  
Quintessence directional luminaires accentuate artwork, products and architectural details effectively. The ideal angle of tilt ( $\alpha$ ) for this is around  $20^\circ$ . The object is modelled without distorting the effect as a result of excessive shadowing. It also prevents shadows cast by the observer.

Arrangement:  $\alpha = 20^\circ$

**Downlights**  
Extra wide flood

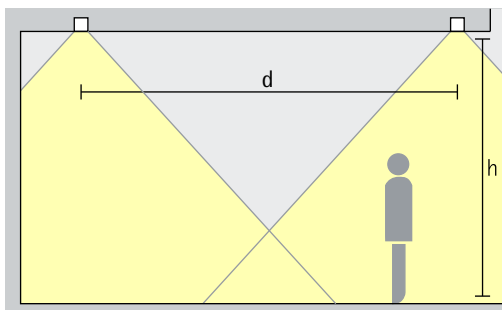

**General lighting**  
For uniform ambient lighting, the spacing ( $d$ ) between two Quintessence downlights may be up to approximately 1.5 times the height ( $h$ ) of the luminaire above the working plane.

Arrangement:  $d \leq 1.5 \times h$

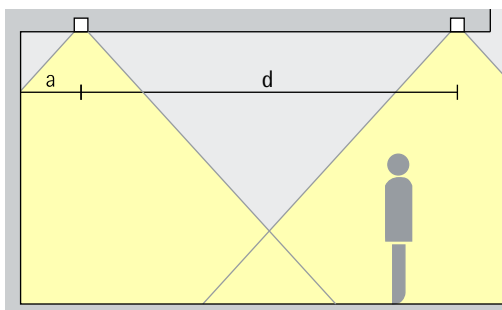

The wall offset should be half the luminaire spacing.

Arrangement:  $a = d / 2$

**Lens wallwashers**  
Wallwash

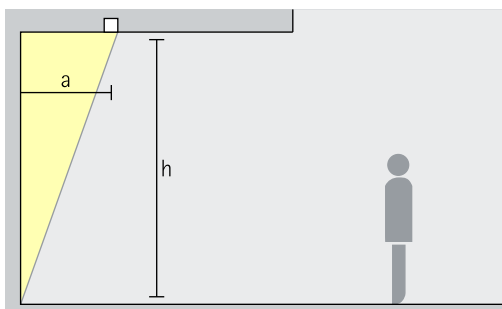

**Wallwashing**  
For uniform vertical illuminance, the distance ( $a$ ) of Quintessence lens wallwashers from the wall should be around one third of the room height ( $h$ ).

Arrangement:  $a = 1/3 \times h$

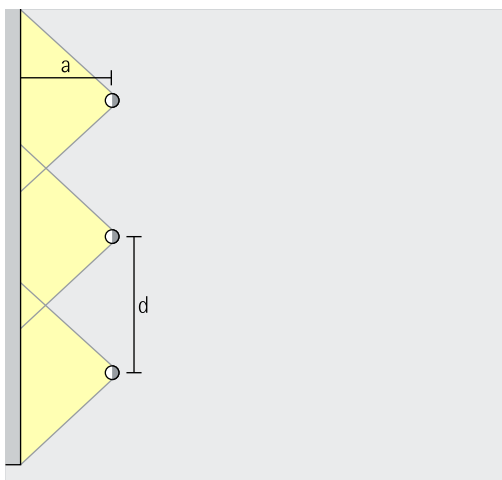

For good longitudinal uniformity, the spacing ( $d$ ) of Quintessence lens wallwashers may be up to 1.3 times the offset from the wall ( $a$ ).

Arrangement:  $d \leq 1.3 \times a$

The optimal wall offset and luminaire spacing for each product are indicated in the wallwasher tables in the catalogue and the product data sheets.

Intercontinental  
Resort, Berchtesgaden. Architect:  
Kochta Architekten, Munich.  
Electrical design:  
Ingenieurbüro  
Schnell, Tuttlingen.



# Quintessence round Recessed luminaires

Construction size

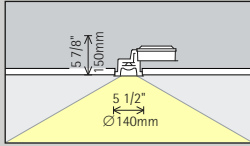

Size 3

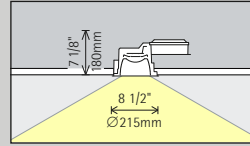

Size 5

LED module  
Maximum value at 4000K CRI 82

12W/1650lm	2W/275lm (Narrow spot)
------------	------------------------

24W/3300lm	6W/825lm (Narrow spot)
------------	------------------------

Light color

	2700K CRI 92 *		3500K CRI 92 *
	3000K CRI 92		4000K CRI 82
	3000K CRI 97 *		4000K CRI 92 *

	2700K CRI 92 *		3500K CRI 92 *
	3000K CRI 92		4000K CRI 82
	3000K CRI 97 *		4000K CRI 92 *

Light distribution

Downlights	Directional luminaires
Extra wide flood	Narrow spot
Lens wallwashers	Spot
Wallwash	Flood

Downlights	Directional luminaires
Extra wide flood	Narrow spot
Lens wallwashers	Spot
Wallwash	Flood

Control

	Trailing edge dimmable
	Switchable **

	Trailing edge dimmable
--	------------------------

Color (housing)

	Silver
--	--------

	Silver
--	--------

Accessories

	Concrete housing
--	------------------



Intercontinental  
Resort, Berchtes-  
gaden. Architect:  
Kochta Architek-  
ten, Munich.  
Electrical design:  
Ingenieurbüro  
Schnell, Tuttlin-  
gen.

\* available on request  
\*\* Only for narrow spot light distribution

Article numbers and planning data:  
[www.erco.com/015746-us](http://www.erco.com/015746-us)

Design and application:  
[www.erco.com/quintessence-o](http://www.erco.com/quintessence-o)





