

LED

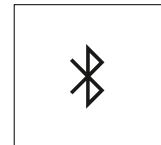

55268.000 White (RAL9002)
 LED module: 6W 620lm 2700K warm white
 Casambi Bluetooth
 Version 4
 Zoom lens spot

Product description
 Housing and bracket: cast aluminium, powder-coated. 0°-90° tilt. Bracket on 3-circuit adapter rotatable through 360°. Internal wiring. ERCO Casambi control gear. 3-phase adapter for ERCO 220-240V track: polymer, white.
 LED module: high-power LEDs on metal-core PCB. Collimating lens made of optical polymer.
 Zoom attachment: polymer, coated. Zoom lens, continuously focusable
 Control via Casambi app (Android/iOS) with Bluetooth Low Energy (BLE)-capable mobile devices or "Casambi Ready" products.
 Weight 0.75kg
 Housing temperature 40°C

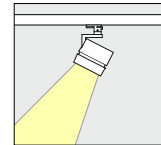
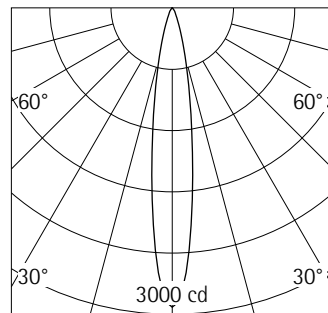

h(m)	E(lx)	D(m)
		16°
1	2930	0.28
2	733	0.56
3	326	0.84
4	183	1.12
5	117	1.41

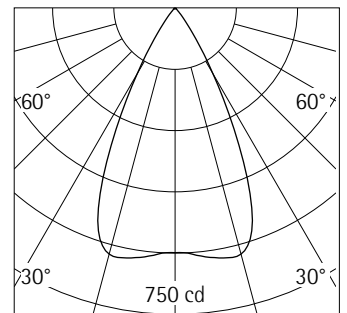

h(m)	E(lx)	D(m)
		53°
1	599	1.00
2	150	1.99
3	67	2.99
4	37	3.99
5	24	4.99

Technical data

Luminous flux of the luminaire	412lm
Connected load	8.6W
Luminaire efficacy	48lm/W
Colour deviation	1.5 SDCM
Colour rendition index	CRI 92
Lumen maintenance (LED manufacturer specifications)	L90/B10 ≤50000h L90 ≤100000h
LED failure rate	0.1% ≤50000h
Dimming range	0.1%-100%
Dimming method	CCR
LMF	E
Standby power per control gear	0.4W
Luminaires per circuit breaker B16	260

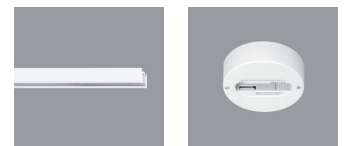

Mounting

ERCO 3-circuit track
 Hi-trac 3-circuit track
 1-circuit singlet

For your regional contact in the ERCO
 Sales network click here
www.ercos.com/contact

Technical Region: 220-240V 50/60Hz
 We reserve the right to make technical and design changes.
 Edition: 16.11.2022
 Current version under
www.ercos.com/55268.000

Planning data

Cleaning (a)	1				2				3			
	P	C	N	D	P	C	N	D	P	C	N	D
LMF	0.96	0.94	0.90	0.86	0.93	0.91	0.86	0.81	0.92	0.90	0.84	0.79
RSMF	0.99	0.97	0.95	0.92	0.98	0.97	0.95	0.92	0.98	0.97	0.95	0.92

Hours of operation (h)	1000	5000	10000	20000	30000	40000	50000
LLMF	1.00	0.99	0.98	0.96	0.94	0.92	0.90
LSF	1	1	1	1	1	1	1

- MF LMFxRSMFxLLMFxLSF
- MF Maintenance Factor
- LMF Luminaire Maintenance Factor
- RSMF Room Surface Maintenance Factor
- LLMF Lamp Lumens Maintenance Factor
- LSF Lamp Survival Factor
- P Room pure
- C Room clean
- N Room normal
- D Room dirty

Data according to regulations

2019/2020/EU supplemented by 2021/341/EU and 2019/2015/EU supplemented by 2021/340/EU Energy Consumption Labelling Ordinance

This product contains a light source of efficiency class F
 Due to thermal and photometric properties as well as to protect electronic components from ESD (electrostatic discharge) the light source cannot be changed by the customer.

ID EPREL: 696733
 Model identifier: 3000054466
 Download data sheets for control gear and disassembly instructions at www.erco.com/slr

Technical data in accordance with international norms and standards

- IEC 60598 Luminaires – Part 1+2: general requirements, specific requirements and tests
- IEC 62031 LED modules for general lighting – safety requirements
- IEC 62471 Photobiological safety of lamps and lamp systems
- EN 13032-4 Light and lighting – measurement and representation of photometric data
- CIE 13 Method of measuring and specifying colour rendering properties of light sources

All technical data is subject to industry-standard tolerances.
 Also see www.erco.com/erco-led

For explanations of the symbols and abbreviations used and other general information, see www.erco.com/symbols

Accessories

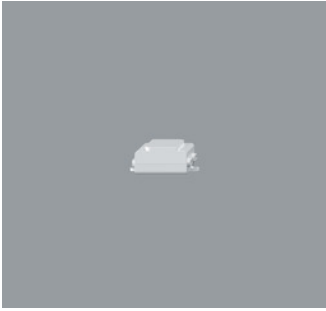

55251.000
 DALI Casambi Gateway
 Enables DALI systems to be connected to luminaires, sensors and control units with Casambi Bluetooth. The gateway can only be operated in Evolution networks. Power is supplied exclusively via the DALI bus. Connection via two lines which must be designed for mains voltage. The gateway requires no DALI addresses, the devices appear as non-configured devices in the DALI system. Addressing/commissioning is performed via the DALI control. It can individually control 64 devices, and via the broadcast command up to 249 devices.
 This article is identical with article AC007001.

CE UK

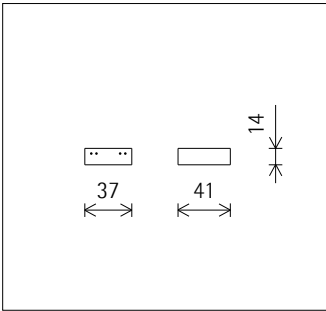

55248.000
 ERCO Casambi motion detector with light sensor for ERCO 220-240V track.
 Setup via Casambi app (Android/iOS) with Bluetooth Low Energy (BLE)-capable mobile devices.
 Use for daylight-dependent light control with or without motion detector. Detection range of infrared (PIR) sensor 100°/ 5m. At 3m room height, this is a circle with diameter of approx. 7m.
 3-phase adapter for ERCO 220-240V track: plastic, white.

White
 Weight 0.18kg
 CE UK



55249.000
 ERCO Casambi motion detector with light sensor for ERCO 220-240V track.
 Setup via Casambi app (Android/iOS) with Bluetooth Low Energy (BLE)-capable mobile devices.
 Use for daylight-dependent light control with or without motion detector. Detection range of infrared (PIR) sensor 100°/ 5m. At 3m room height, this is a circle with diameter of approx. 7m.
 3-phase adapter for ERCO 220-240V track: polymer, black.

Black
 Weight 0.18kg
 CE UK