

with Intrack adapter

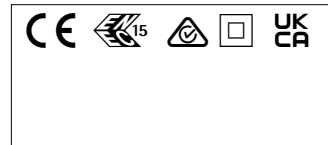

A1005299 White (RAL9002)
 LED module: 8.1W 1086lm 4000K
 neutral white
 Casambi Bluetooth
 Version 1
 Size S
 Lens Unit wide framing

Product description
 Housing: cast aluminium, powder-coated; can be swivelled through 90° on the bracket. Upper cover made of polymer.
 Bracket: cast aluminium/polymer, coated; can be rotated through 360° on the adapter.
 Intrack adapter for ERCO 220-240V track: polymer, white.
 ERCO control gear.
 Add-on control unit: Casambi Bluetooth.
 LED module: high-power LEDs. Collimating lens made of optical polymer.
 Lens Unit: Aluminium/polymer, coated white, pivotable through 360°. 2 projection lenses, continuously focusable. Ideal for short projection distances.
 Framing attachment: stainless steel, black. Aperture.
 Control via Casambi app (Android/iOS) with Bluetooth Low Energy (BLE)-capable mobile devices or "Casambi Ready" products.
 Protection Class II
 Weight 0.48kg

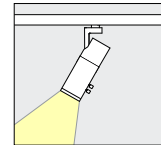
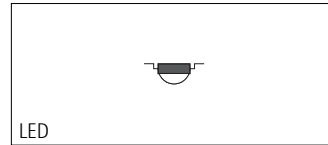
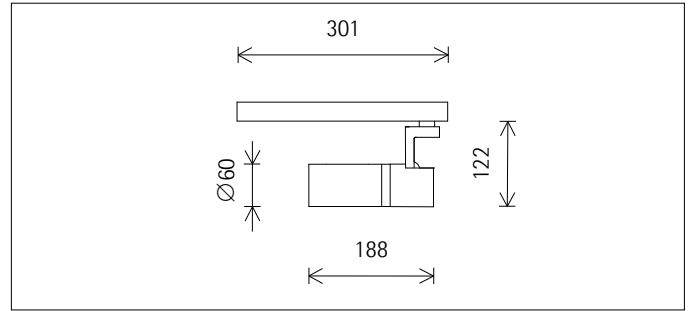
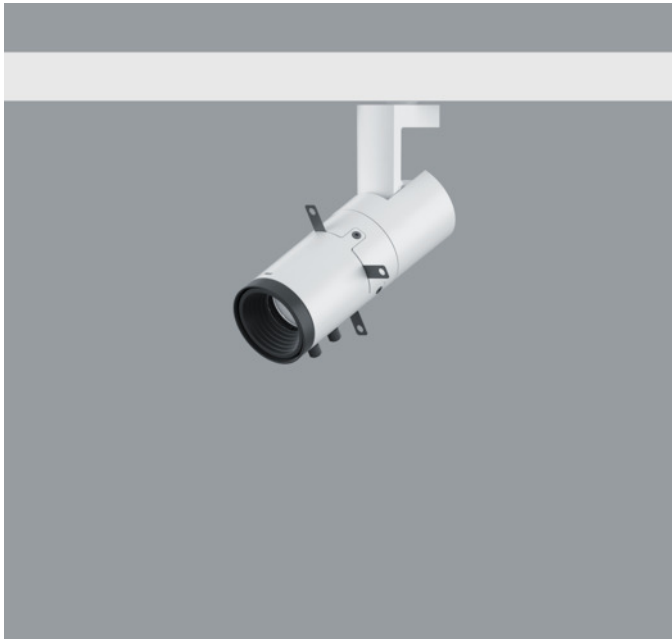
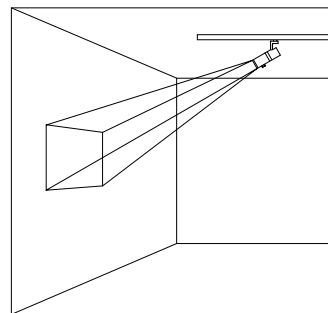

Measured illuminance levels (new values) E (lx) and maximum edge length D (m) of square projection through framing attachment dependent on projection distance h (m)

h (m)	E (lx)	D (m)
1	584	0.62
2	146	1.24
3	65	1.86
4	37	2.48
5	23	3.10

Technical data

Luminous flux of the luminaire	194lm
Connected load	9.4W
Luminaire efficacy	21lm/W
Colour deviation	1.5 SDCM
Colour rendition index	CRI 82
Lumen maintenance (LED manufacturer specifications)	L90/B10 ≤50000h L90 ≤100000h
LED failure rate	0.1% ≤50000h
Dimming range	0.1%-100%
Dimming method	CCR
LMF	E
Standby power per control gear	0.4W
Luminaires per circuit breaker B16	328

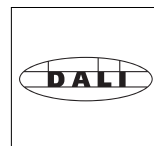

DALI controllable via accessory
 DALI Casambi Gateway for controlling Casambi Bluetooth via DALI.



Mounting
 ERCO 3-circuit track
 Hi-trac 3-circuit track

Planning data

Melanopic light effect

Art. no.	Spectrum	MR	MDER
A1005299 (direct)	4000K CRI 82	0.68	0.62

MR Melanopic ratio according to DIN SPEC 5031-100-100:2015-08: "amel;v"

MDER Melanopic daylight equivalent ratio according to DIN SPEC 5031-100-100:2015-08: "amel;D65;v"

Multiplying the melanopic ratio MR with the illuminance gives the equivalent melanopic illuminance EML (equivalent melanopic lux). The equivalent illuminance with daylight (D65) is obtained by multiplying the illuminance by the melanopic daylight equivalent ratio MDER.

Cleaning (a)	1				2				3			
	P	C	N	D	P	C	N	D	P	C	N	D
LMF	0.96	0.94	0.90	0.86	0.93	0.91	0.86	0.81	0.92	0.90	0.84	0.79
RSMF	0.99	0.97	0.95	0.92	0.98	0.97	0.95	0.92	0.98	0.97	0.95	0.92

Hours of operation (h)	1000	5000	10000	20000	30000	40000	50000
LLMF	1.00	0.99	0.98	0.96	0.94	0.92	0.90
LSF	1	1	1	1	1	1	1

MF	LMF x RSMF x LLMF x LSF
MF	Maintenance Factor
LMF	Luminaire Maintenance Factor
RSMF	Room Surface Maintenance Factor
LLMF	Lamp Lumens Maintenance Factor
LSF	Lamp Survival Factor
P	Room pure
C	Room clean
N	Room normal
D	Room dirty

Data according to regulations

2019/2020/EU supplemented by 2021/341/EU and 2019/2015/EU supplemented by 2021/340/EU Energy Consumption Labelling Ordinance

This product contains a light source of efficiency class D

Due to thermal and photometric properties as well as to protect electronic components from ESD (electrostatic discharge) the light source cannot be changed by the customer.

ID EPREL: 985717

Model identifier: 3000057847

Download data sheets for control gear and disassembly instructions at www.erco.com/slr

Technical data in accordance with international norms and standards

IEC 60598	Luminaires – Part 1+2: general requirements, specific requirements and tests
IEC 62031	LED modules for general lighting – safety requirements
IEC 62471	Photobiological safety of lamps and lamp systems
EN 13032-4	Light and lighting – measurement and representation of photometric data
CIE 13	Method of measuring and specifying colour rendering properties of light sources

All technical data is subject to industry-standard tolerances.

Also see www.erco.com/erco-led

For explanations of the symbols and abbreviations used and other general information, see www.erco.com/symbols

Accessories

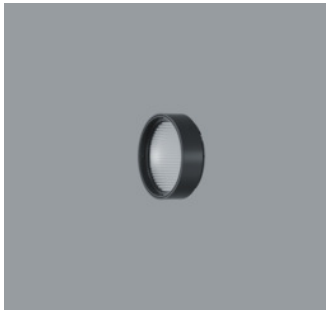

AC002064
 Lens unit spot
 Polymer, black lacquered, rotatable through 360°. Replacement without tools.
 Spherolit lens made of optical polymer.

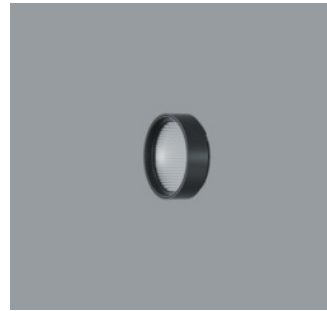

AC002063
 Lens unit extra wide flood
 Polymer, black lacquered, rotatable through 360°. Replacement without tools.
 Spherolit lens made of optical polymer.

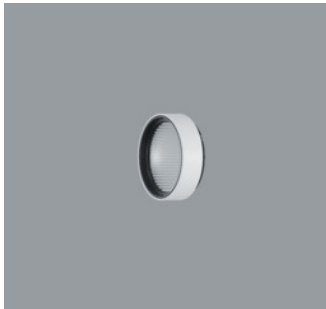

AC002099
 Lens unit spot
 Polymer, white, rotatable through 360°. Replacement without tools.
 Spherolit lens made of optical polymer.



AC002098
 Lens unit extra wide flood
 Polymer, white, rotatable through 360°. Replacement without tools.
 Spherolit lens made of optical polymer.

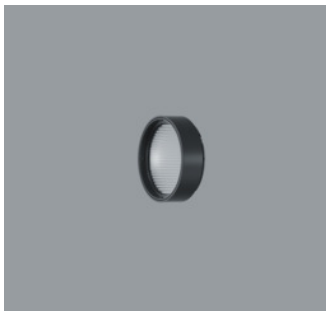

AC002062
 Lens unit flood
 Polymer, black lacquered, rotatable through 360°. Replacement without tools.
 Spherolit lens made of optical polymer.

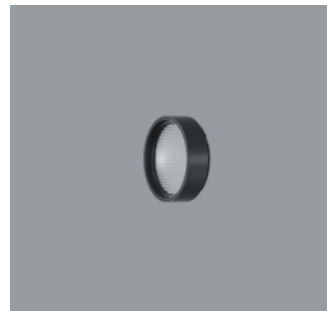

AC002061
 Lens unit oval flood
 Polymer, black lacquered, rotatable through 360°. Replacement without tools.
 Spherolit lens made of optical polymer.

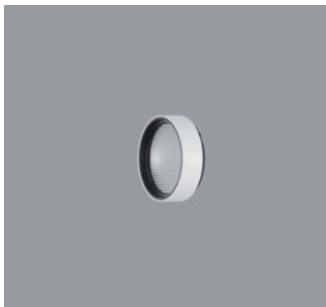

AC002097
 Lens unit flood
 Polymer, white, rotatable through 360°. Replacement without tools.
 Spherolit lens made of optical polymer.



AC002095
 Lens unit oval flood
 Polymer, white, rotatable through 360°. Replacement without tools.
 Spherolit lens made of optical polymer.

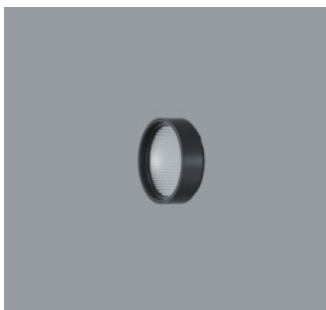

AC002060
 Lens unit wide flood
 Polymer, black lacquered, rotatable through 360°. Replacement without tools.
 Spherolit lens made of optical polymer.

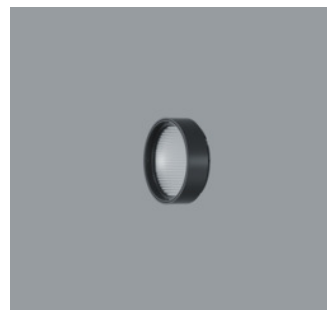

AC002067
 Lens unit oval wide flood
 Polymer, black lacquered, rotatable through 360°. Replacement without tools.
 Spherolit lens made of optical polymer.

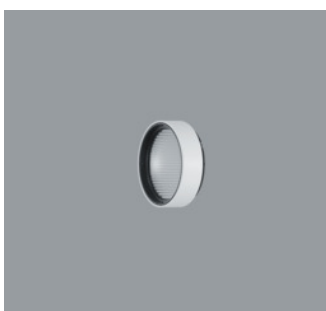

AC002094
 Lens unit wide flood
 Polymer, white, rotatable through 360°. Replacement without tools.
 Spherolit lens made of optical polymer.

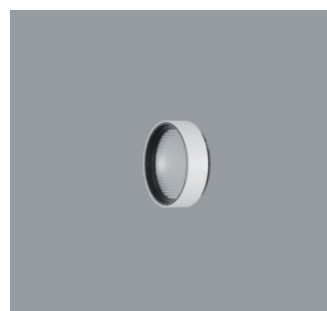

AC002102
 Lens unit oval wide flood
 Polymer, white, rotatable through 360°. Replacement without tools.
 Spherolit lens made of optical polymer.

Accessories

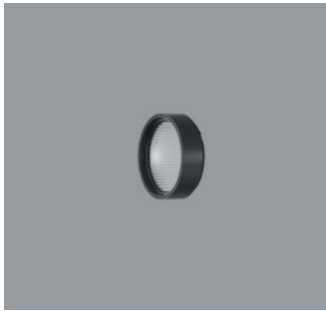

AC002065
 Lens unit wallwash
 Polymer, black lacquered, rotatable through 360°. Replacement without tools.
 Spherolit lens made of optical polymer.



AC002258
 Lens unit narrow framing
 Aluminium/polymer, coated white, pivotable through 360°. Replacement without tools.
 Projection lens, continuously focusable. Ideal for long projection distances.
 Framing attachment: stainless steel, black.
 Aperture.

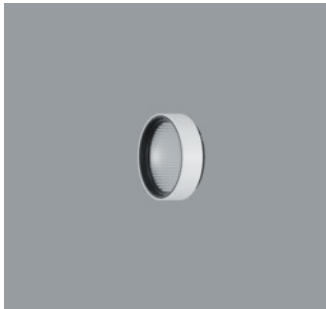

AC002100
 Lens unit wallwash
 Polymer, white, rotatable through 360°. Replacement without tools.
 Spherolit lens made of optical polymer.



AC002263
 Lens unit narrow framing
 Aluminium/polymer, coated black, pivotable through 360°. Replacement without tools.
 Projection lens, continuously focusable. Ideal for long projection distances.
 Framing attachment: stainless steel, black.
 Aperture.

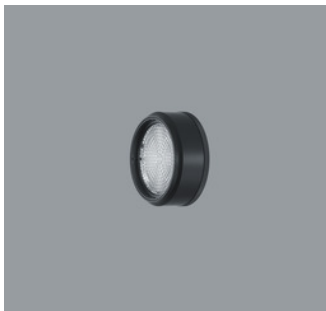

AC002122
 Lens unit zoom spot
 Polymer, black lacquered, rotatable through 360°. Replacement without tools.
 Anti-reflective zoom lens made of optical polymer, infinitely variable focus.



AC002261
 Lens unit wide framing
 Aluminium/polymer, coated white, pivotable through 360°. Replacement without tools.
 2 projection lenses, continuously focusable. Ideal for short projection distances.
 Framing attachment: stainless steel, black.
 Aperture.



AC002127
 Lens unit zoom spot
 Polymer, white, rotatable through 360°. Replacement without tools.
 Anti-reflective zoom lens made of optical polymer, infinitely variable focus.



AC002266
 Lens unit wide framing
 Aluminium/polymer, coated black, pivotable through 360°. Replacement without tools.
 2 projection lenses, continuously focusable. Ideal for short projection distances.
 Framing attachment: stainless steel, black.
 Aperture.

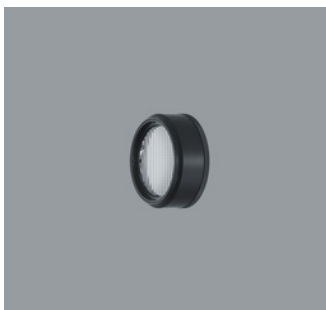

AC002123
 Lens unit zoom oval
 Polymer, black lacquered, rotatable through 360°. Replacement without tools.
 Anti-reflective zoom lens made of optical polymer, infinitely variable focus.

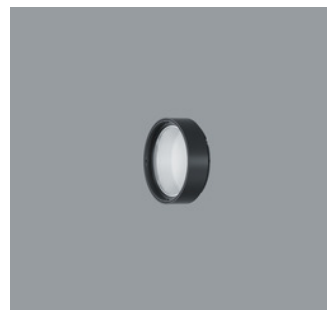

AC006002
 Softening lens
 Filter holder: polymer, black, rotatable through 360°. Replacement without tools.



AC002128
 Lens unit zoom oval
 Polymer, white, rotatable through 360°. Replacement without tools.
 Anti-reflective zoom lens made of optical polymer, infinitely variable focus.

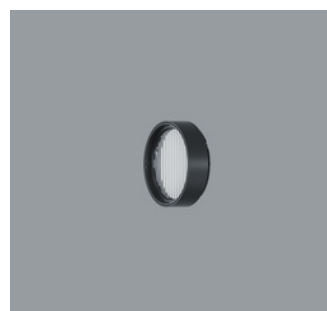

AC006025
 Sculpture lens
 Filter holder: polymer, black, rotatable through 360°. Replacement without tools.

Accessories

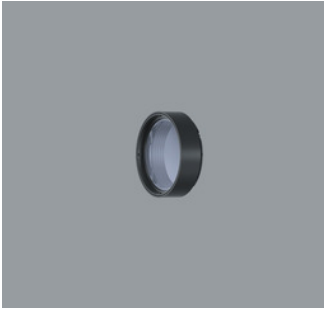

AC006009
Cold Filter
Filter holder: polymer, black, rotatable through 360°. Replacement without tools.

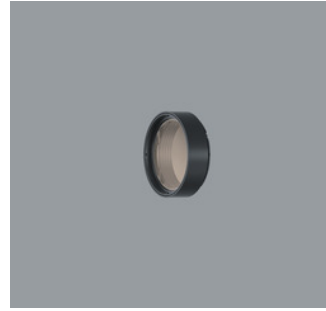

AC006010
Marbled Meat Filter
Filter holder: polymer, black, rotatable through 360°. Replacement without tools.

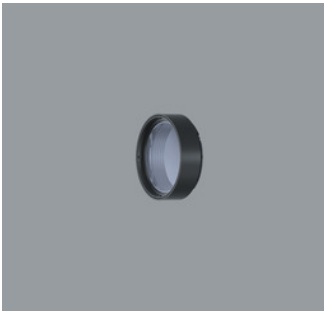

AC006007
Cold Filter Plus
Filter holder: polymer, black, rotatable through 360°. Replacement without tools.

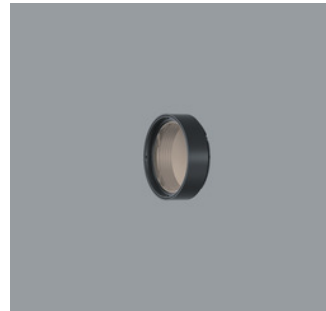

AC006008
Bread and Pastry Filter
Filter holder: polymer, black, rotatable through 360°. Replacement without tools.

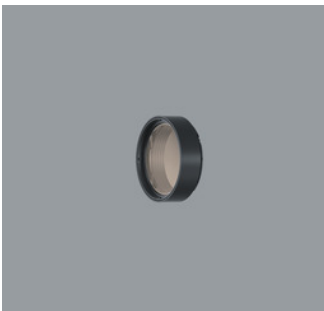

AC006005
Warm Filter
Filter holder: polymer, black, rotatable through 360°. Replacement without tools.

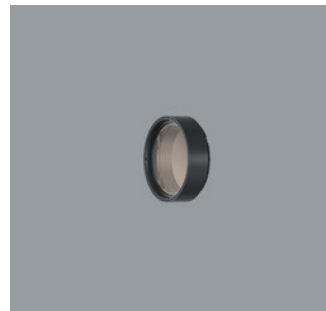

AC006004
Blue Light Filter
Filter holder: polymer, black, rotatable through 360°. Replacement without tools.

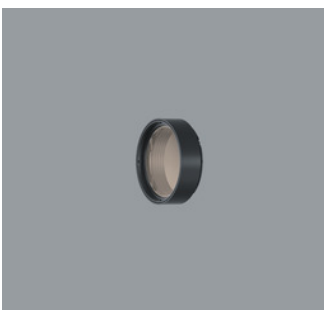

AC006003
Warm Filter Plus
Filter holder: polymer, black, rotatable through 360°. Replacement without tools.



AC004024
Honeycomb anti-glare screen
Black

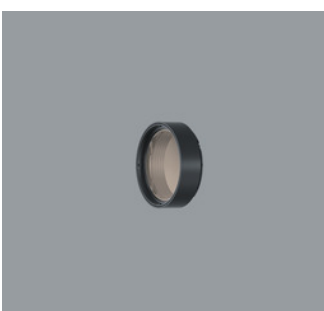

AC006006
Skintone Filter
Filter holder: polymer, black, rotatable through 360°. Replacement without tools.



AC003002
Add-on Control Unit On-board Dim
Polymer, black. Replacement without tools.
Rotary control for brightness regulation.

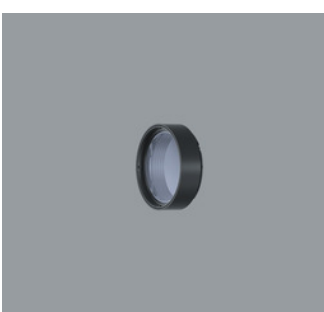

AC006013
Fish Filter
Filter holder: polymer, black, rotatable through 360°. Replacement without tools.

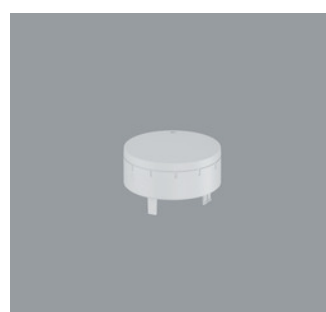

AC003006
Add-on Control Unit On-board Dim
Polymer, white. Replacement without tools.
Rotary control for brightness regulation.

Accessories

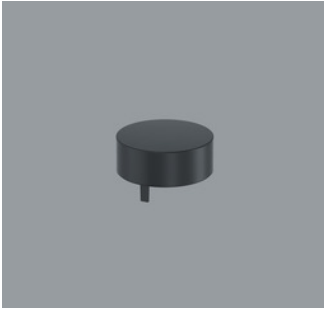

AC003004
Add-on Control Unit Zigbee
Polymer, black. Replacement without tools.
Control via a Zigbee 3.0 compliant hub.

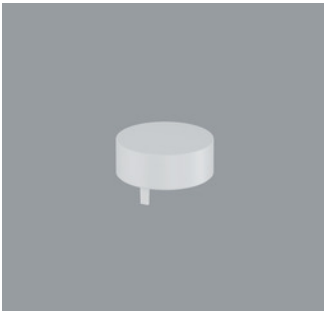

AC003008
Add-on Control Unit Zigbee
Polymer, white. Replacement without tools.
Control via a Zigbee 3.0 compliant hub.

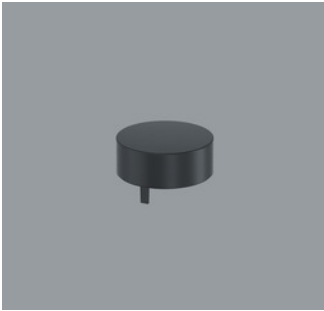

AC003001
Add-on Control Unit Casambi Bluetooth
Polymer, black. Replacement without tools.
Control via Casambi app (Android/iOS) with Bluetooth Low Energy (BLE)-capable mobile devices or "Casambi Ready" products.

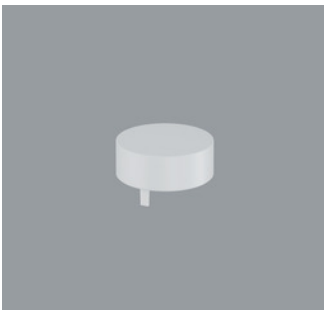

AC003005
Add-on Control Unit Casambi Bluetooth
Polymer, white. Replacement without tools.
Control via Casambi app (Android/iOS) with Bluetooth Low Energy (BLE)-capable mobile devices or "Casambi Ready" products.

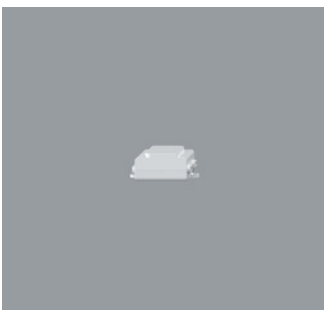

AC007001
DALI Casambi Gateway
Enables DALI systems to be connected to luminaires, sensors and control units with Casambi Bluetooth. The gateway can only be operated in Evolution networks. Power is supplied exclusively via the DALI bus. Connection via two lines which must be designed for mains voltage. The gateway requires no DALI addresses, the devices appear as non-configured devices in the DALI system. Addressing/commissioning is performed via the DALI control. It can individually control 64 devices, and via the broadcast command up to 249 devices.

CE

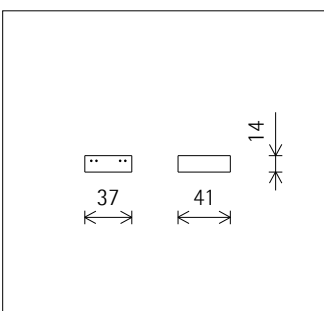

55248.000
ERCO Casambi motion detector with light sensor for ERCO 220-240V track. Setup via Casambi app (Android/iOS) with Bluetooth Low Energy (BLE)-capable mobile devices. Use for daylight-dependent light control with or without motion detector. Detection range of infrared (PIR) sensor 100°/ 5m. At 3m room height, this is a circle with diameter of approx. 7m. 3-phase adapter for ERCO 220-240V track: plastic, white.
White
Weight 0.18kg



55249.000
ERCO Casambi motion detector with light sensor for ERCO 220-240V track. Setup via Casambi app (Android/iOS) with Bluetooth Low Energy (BLE)-capable mobile devices. Use for daylight-dependent light control with or without motion detector. Detection range of infrared (PIR) sensor 100°/ 5m. At 3m room height, this is a circle with diameter of approx. 7m. 3-phase adapter for ERCO 220-240V track: polymer, black.
Black
Weight 0.18kg