

A1035090 White (RAL9002)
 LED module: 25.1W 2797lm 3000K
 warm white
 Casambi Bluetooth
 Version 1
 Size L
 Lens Unit wide framing

Product description
 Housing: cast aluminium, powder-coated; can be swivelled through 90° on the bracket. Upper cover made of polymer.
 Bracket: cast aluminium/polymer, coated; can be rotated through 360° on the adapter.
 3-phase adapter for ERCO 220-240V track: polymer, white.
 Casambi control gear.
 LED module: high-power LEDs. Collimating lens made of optical polymer.
 Lens Unit: Aluminium/polymer, coated white, pivotable through 360°. 2 projection lenses, continuously focusable. Ideal for short projection distances.
 Framing attachment: stainless steel, black. Aperture.
 For ceiling mounting only.
 Install the luminaire out of people's normal reach.
 Control via Casambi app (Android/iOS) with Bluetooth Low Energy (BLE)-capable mobile devices or "Casambi Ready" products.
 Weight 1.85kg

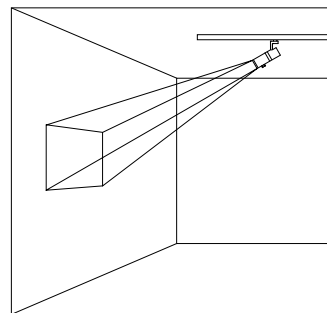

Measured illuminance levels (new values) E (lx) and maximum edge length D (m) of square projection through framing attachment dependent on projection distance h (m)

h (m)	E (lx)	D (m)
1	1232	0.79
2	308	1.57
3	137	2.36
4	77	3.15
5	49	3.93

Technical data

Luminous flux of the luminaire	618lm
Connected load	28.6W
Luminaire efficacy	22lm/W
Colour deviation	1.5 SDCM
Colour rendition index	CRI 92
Lumen maintenance (LED manufacturer specifications)	L90/B10 ≤50000h L90 ≤100000h
LED failure rate	0.1% ≤50000h
Dimming range	1%-100%
Dimming method	CCR
LMF	E
Standby power per control gear	0.5W
Luminaires per circuit breaker B16	50

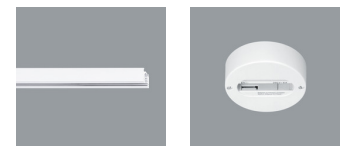

Mounting
 ERCO 3-circuit track
 Hi-trac 3-circuit track
 1-circuit singlet

Planning data

Melanopic light effect

Art. no.	Spectrum	MR	MDER
A1035090 (direct)	3000K CRI 92	0.54	0.48

MR Melanopic ratio according to DIN SPEC 5031-100-100:2015-08: "amel;v"

MDER Melanopic daylight equivalent ratio according to DIN SPEC 5031-100-100:2015-08: "amel;D65;v"

Multiplying the melanopic ratio MR with the illuminance gives the equivalent melanopic illuminance EML (equivalent melanopic lux). The equivalent illuminance with daylight (D65) is obtained by multiplying the illuminance by the melanopic daylight equivalent ratio MDER.

Cleaning (a)	1				2				3			
	P	C	N	D	P	C	N	D	P	C	N	D
LMF	0.96	0.94	0.90	0.86	0.93	0.91	0.86	0.81	0.92	0.90	0.84	0.79
RSMF	0.99	0.97	0.95	0.92	0.98	0.97	0.95	0.92	0.98	0.97	0.95	0.92

Hours of operation (h)	1000	5000	10000	20000	30000	40000	50000
LLMF	1.00	0.99	0.98	0.96	0.94	0.92	0.90
LSF	1	1	1	1	1	1	1

- MF LMFxRSMFxLLMFxLSF
- MF Maintenance Factor
- LMF Luminaire Maintenance Factor
- RSMF Room Surface Maintenance Factor
- LLMF Lamp Lumens Maintenance Factor
- LSF Lamp Survival Factor
- P Room pure
- C Room clean
- N Room normal
- D Room dirty

Data according to regulations

2019/2020/EU supplemented by 2021/341/EU and 2019/2015/EU supplemented by 2021/340/EU Energy Consumption Labelling Ordinance

This product contains a light source of efficiency class E
 Due to thermal and photometric properties as well as to protect electronic components from ESD (electrostatic discharge) the light source cannot be changed by the customer.

ID EPREL: 985720
 Model identifier: 3000060580
 Download data sheets for control gear and disassembly instructions at www.erco.com/slr

Technical data in accordance with international norms and standards

IEC 60598	Luminaires – Part 1+2: general requirements, specific requirements and tests
IEC 62031	LED modules for general lighting – safety requirements
IEC 62471	Photobiological safety of lamps and lamp systems
EN 13032-4	Light and lighting – measurement and representation of photometric data
CIE 13	Method of measuring and specifying colour rendering properties of light sources

All technical data is subject to industry-standard tolerances.
 Also see www.erco.com/erco-led

For explanations of the symbols and abbreviations used and other general information, see www.erco.com/symbols

Accessories



AC002255
 Lens unit narrow framing
 Aluminium/polymer, coated black,
 pivotable through 360°. Replacement
 without tools.
 Projection lens, continuously focusable.
 Ideal for long projection distances.
 Framing attachment: stainless steel,
 black.
 Aperture.

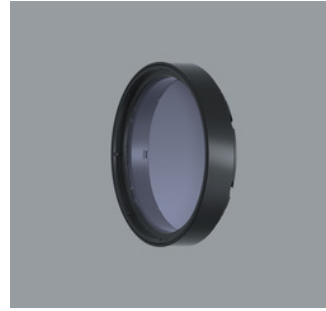

AC006038
 Cold Filter
 Filter holder: polymer, black, rotatable
 through 360°. Replacement without
 tools.



AC002256
 Lens unit narrow framing
 Aluminium/polymer, coated white,
 pivotable through 360°. Replacement
 without tools.
 Projection lens, continuously focusable.
 Ideal for long projection distances.
 Framing attachment: stainless steel,
 black.
 Aperture.

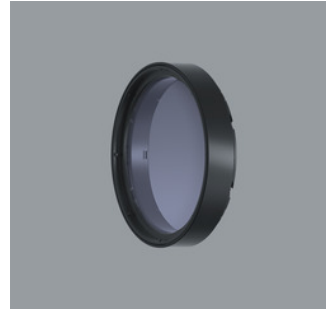

AC006036
 Cold Filter Plus
 Filter holder: polymer, black, rotatable
 through 360°. Replacement without
 tools.



AC002259
 Lens unit wide framing
 Aluminium/polymer, coated white,
 pivotable through 360°. Replacement
 without tools.
 2 projection lenses, continuously
 focusable. Ideal for short projection
 distances.
 Framing attachment: stainless steel,
 black.
 Aperture.



AC006049
 Warm Filter
 Filter holder: polymer, black, rotatable
 through 360°. Replacement without
 tools.



AC002264
 Lens unit wide framing
 Aluminium/polymer, coated black,
 pivotable through 360°. Replacement
 without tools.
 2 projection lenses, continuously
 focusable. Ideal for short projection
 distances.
 Framing attachment: stainless steel,
 black.
 Aperture.



AC006048
 Warm Filter Plus
 Filter holder: polymer, black, rotatable
 through 360°. Replacement without
 tools.



AC006035
 Softening lens
 Filter holder: polymer, black, rotatable
 through 360°. Replacement without
 tools.

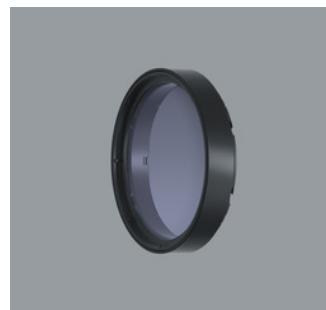

AC006039
 Skintone Filter
 Filter holder: polymer, black, rotatable
 through 360°. Replacement without
 tools.



AC006043
 Sculpture lens
 Filter holder: polymer, black, rotatable
 through 360°. Replacement without
 tools.

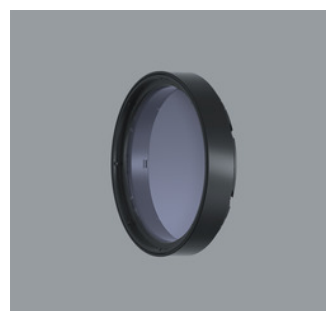

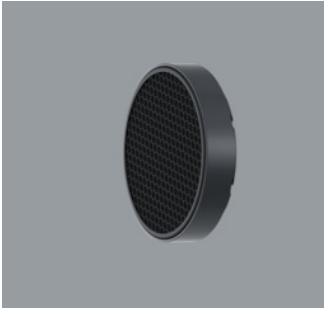

AC006037
 Blue Light Filter
 Filter holder: polymer, black, rotatable
 through 360°. Replacement without
 tools.

Accessories



AC004026
 Honeycomb anti-glare screen
 Aluminium, powder-coated black,
 polymer outer.



55248.000
 ERCO Casambi motion detector with
 light sensor
 for ERCO 220-240V track.
 Setup via Casambi app (Android/iOS)
 with Bluetooth Low Energy (BLE)-
 capable mobile devices.
 Use for daylight-dependent light control
 with or without motion detector.
 Detection range of infrared (PIR) sensor
 100°/ 5m. At 3m room height, this is a
 circle with diameter of approx. 7m.
 3-phase adapter for ERCO 220-240V
 track: plastic, white.
 White
 Weight 0.18kg
    



55249.000
 ERCO Casambi motion detector with
 light sensor
 for ERCO 220-240V track.
 Setup via Casambi app (Android/iOS)
 with Bluetooth Low Energy (BLE)-
 capable mobile devices.
 Use for daylight-dependent light control
 with or without motion detector.
 Detection range of infrared (PIR) sensor
 100°/ 5m. At 3m room height, this is a
 circle with diameter of approx. 7m.
 3-phase adapter for ERCO 220-240V
 track: polymer, black.
 Black
 Weight 0.18kg
   