

with transadpter

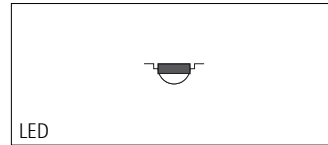

LED

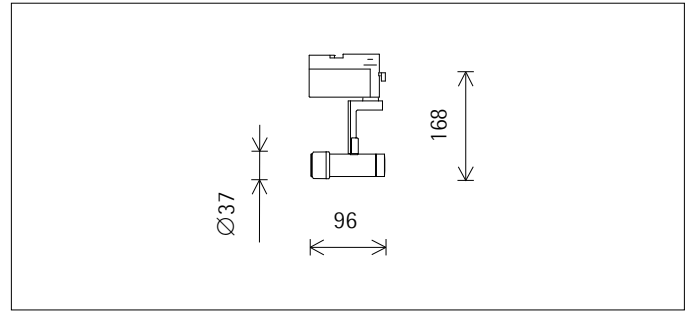
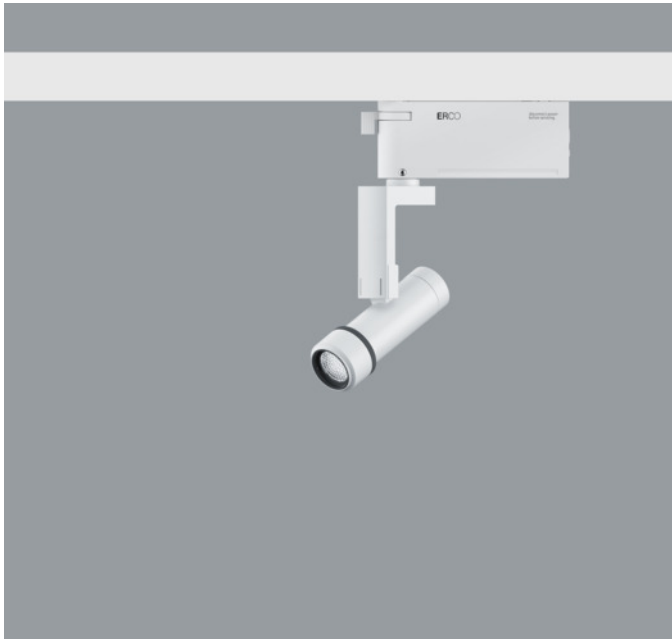
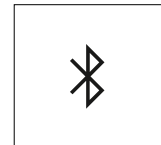
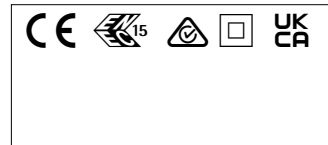
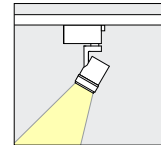

**A1040780** White (RAL9002)  
 LED module: 3.1W 382lm 4000K neutral white  
 Casambi Bluetooth  
 Version 1  
 Size XS  
 Zoom lens oval

**Product description**  
 Housing: Zinc die-cast, powder-coated; can be swivelled through 90° on the bracket. Upper cover made of polymer.  
 Bracket: polymer; can be rotated through 360° on the adapter.  
 Transadpter for ERCO 220-240V track: polymer, white.  
 ERCO Casambi control gear.  
 LED module: high-power LEDs. Collimating lens made of optical polymer.  
 Lens unit: polymer, white, rotatable through 360°. Zoom lens made of optical polymer, infinitely variable focus.  
 Control via Casambi app (Android/iOS) with Bluetooth Low Energy (BLE)-capable mobile devices or "Casambi Ready" products.  
 Protection Class II  
 Weight 0.40kg

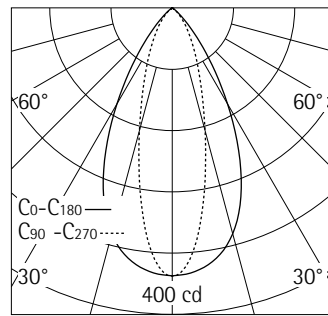

h(m)	E(lx)	D(m)	
		C0	C90
1	350	1.04	0.52
2	87	2.08	1.03
3	39	3.12	1.55
4	22	4.16	2.07
5	14	5.21	2.59

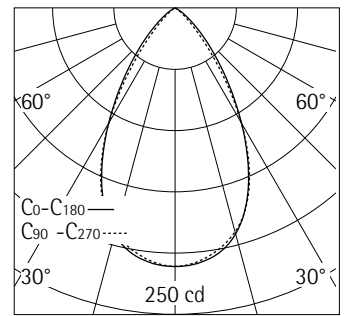

h(m)	E(lx)	D(m)	
		C0	C90
1	211	1.18	1.18
2	53	2.36	2.36
3	23	3.53	3.53
4	13	4.71	4.71
5	8	5.89	5.89

**Technical data**

Luminous flux of the luminaire	210lm
Connected load	5.3W
Luminaire efficacy	40lm/W
Colour deviation	1.5 SDCM
Colour rendition index	CRI 82
Lumen maintenance (LED manufacturer specifications)	L90/B10 ≤50000h L90 ≤100000h
LED failure rate	0.1% ≤50000h
Dimming range	0.1%-100%
Dimming method	CCR
LMF	E
Standby power per control gear	0.4W
Luminaires per circuit breaker B16	260



**Mounting**  
 ERCO 3-circuit track  
 Hi-trac 3-circuit track

For your regional contact in the ERCO  
 Sales network [click here](#)  
[www.ercos.com/contact](http://www.ercos.com/contact)

Technical Region: 220-240V 50/60Hz  
 We reserve the right to make technical and design changes.  
 Edition: 28.01.2023  
 Current version under  
[www.ercos.com/A1040780](http://www.ercos.com/A1040780)

## Planning data

### Melanopic light effect

Art. no.	Spectrum	MR	MDER
A1040780 (direct)	4000K CRI 82	0.68	0.62

MR Melanopic ratio according to DIN SPEC 5031-100-100:2015-08: "amel;v"  
 MDER Melanopic daylight equivalent ratio according to DIN SPEC 5031-100-100:2015-08: "amel;D65;v"

Multiplying the melanopic ratio MR with the illuminance gives the equivalent melanopic illuminance EML (equivalent melanopic lux). The equivalent illuminance with daylight (D65) is obtained by multiplying the illuminance by the melanopic daylight equivalent ratio MDER.

Cleaning (a)	1				2				3			
	P	C	N	D	P	C	N	D	P	C	N	D
LMF	0.96	0.94	0.90	0.86	0.93	0.91	0.86	0.81	0.92	0.90	0.84	0.79
RSMF	0.99	0.97	0.95	0.92	0.98	0.97	0.95	0.92	0.98	0.97	0.95	0.92

Hours of operation (h)	1000	5000	10000	20000	30000	40000	50000
LLMF	1.00	0.99	0.98	0.96	0.94	0.92	0.90
LSF	1	1	1	1	1	1	1

- MF LMFxRSMFxLLMFxLSF
- MF Maintenance Factor
- LMF Luminaire Maintenance Factor
- RSMF Room Surface Maintenance Factor
- LLMF Lamp Lumens Maintenance Factor
- LSF Lamp Survival Factor
- P Room pure
- C Room clean
- N Room normal
- D Room dirty

### Data according to regulations

2019/2020/EU supplemented by 2021/341/EU and 2019/2015/EU supplemented by 2021/340/EU Energy Consumption Labelling Ordinance

This product contains a light source of efficiency class E  
 Due to thermal and photometric properties as well as to protect electronic components from ESD (electrostatic discharge) the light source cannot be changed by the customer.

ID EPREL: 696715  
 Model identifier: 3000053601  
 Download data sheets for control gear and disassembly instructions at [www.erco.com/slr](http://www.erco.com/slr)

### Technical data in accordance with international norms and standards

- IEC 60598 Luminaires – Part 1+2: general requirements, specific requirements and tests
- IEC 62031 LED modules for general lighting – safety requirements
- IEC 62471 Photobiological safety of lamps and lamp systems
- EN 13032-4 Light and lighting – measurement and representation of photometric data
- CIE 13 Method of measuring and specifying colour rendering properties of light sources

All technical data is subject to industry-standard tolerances.  
 Also see [www.erco.com/erco-led](http://www.erco.com/erco-led)

For explanations of the symbols and abbreviations used and other general information, see [www.erco.com/symbols](http://www.erco.com/symbols)

## Accessories

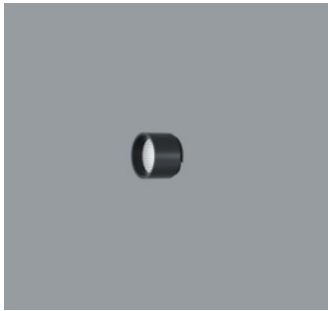

**AC002083**  
 Lens unit spot  
 Polymer, black lacquered, rotatable through 360°. Replacement without tools.  
 Spherolit lens made of optical polymer.

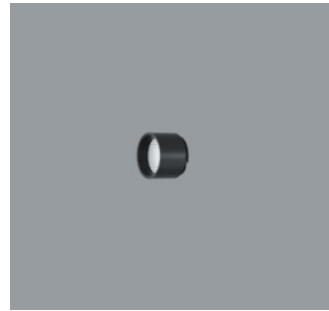

**AC002082**  
 Lens unit extra wide flood  
 Polymer, black lacquered, rotatable through 360°. Replacement without tools.  
 Spherolit lens made of optical polymer.

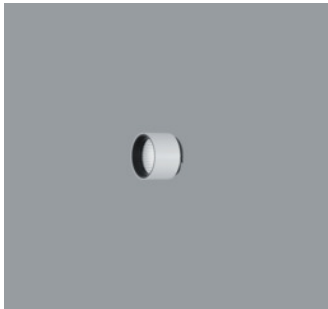

**AC002089**  
 Lens unit spot  
 Polymer, white, rotatable through 360°. Replacement without tools.  
 Spherolit lens made of optical polymer.

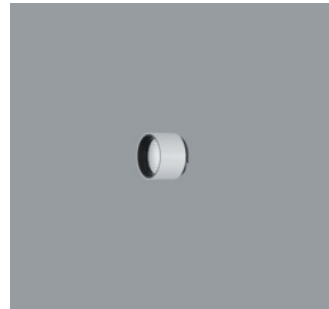

**AC002088**  
 Lens unit extra wide flood  
 Polymer, white, rotatable through 360°. Replacement without tools.  
 Spherolit lens made of optical polymer.

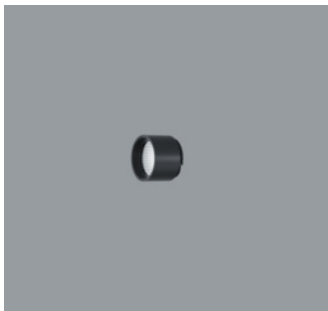

**AC002081**  
 Lens unit flood  
 Polymer, black lacquered, rotatable through 360°. Replacement without tools.  
 Spherolit lens made of optical polymer.

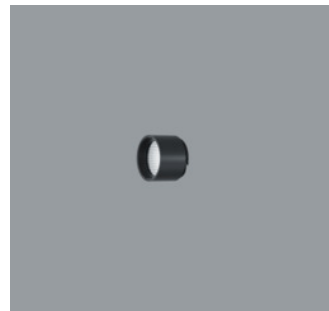

**AC002070**  
 Lens unit oval flood  
 Polymer, black lacquered, rotatable through 360°. Replacement without tools.  
 Spherolit lens made of optical polymer.

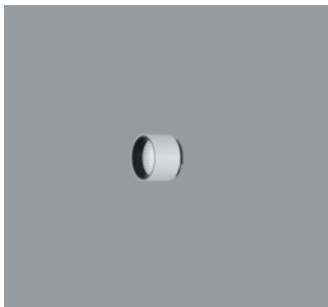

**AC002087**  
 Lens unit flood  
 Polymer, white, rotatable through 360°. Replacement without tools.  
 Spherolit lens made of optical polymer.

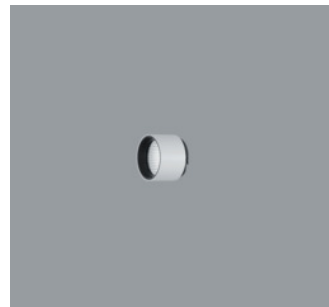

**AC002086**  
 Lens unit oval flood  
 Polymer, white, rotatable through 360°. Replacement without tools.  
 Spherolit lens made of optical polymer.

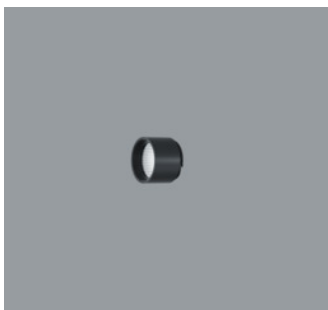

**AC002059**  
 Lens unit wide flood  
 Polymer, black lacquered, rotatable through 360°. Replacement without tools.  
 Spherolit lens made of optical polymer.

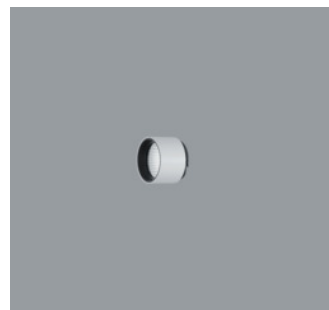

**AC002092**  
 Lens unit oval wide flood  
 Polymer, white, rotatable through 360°. Replacement without tools.  
 Spherolit lens made of optical polymer.

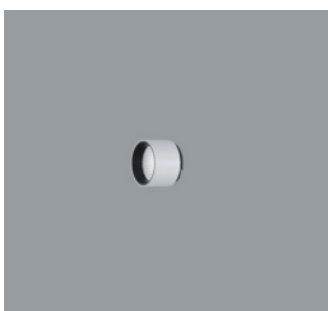

**AC002084**  
 Lens unit wide flood  
 Polymer, white, rotatable through 360°. Replacement without tools.  
 Spherolit lens made of optical polymer.

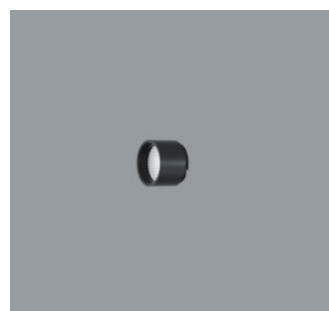

**AC002107**  
 Lens unit oval wide flood  
 Polymer, black lacquered, rotatable through 360°. Replacement without tools.  
 Spherolit lens made of optical polymer.

## Accessories

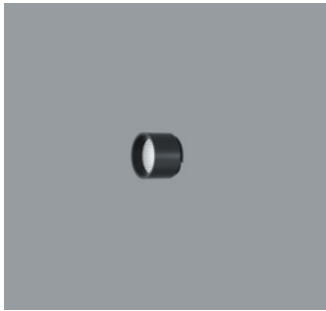

**AC002085**  
 Lens unit wallwash  
 Polymer, black lacquered, rotatable through 360°. Replacement without tools.  
 Spherolit lens made of optical polymer.

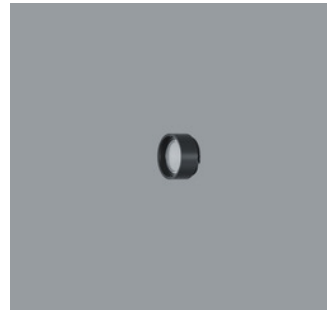

**AC006014**  
 Softening lens  
 Filter holder: polymer, black, rotatable through 360°. Replacement without tools.

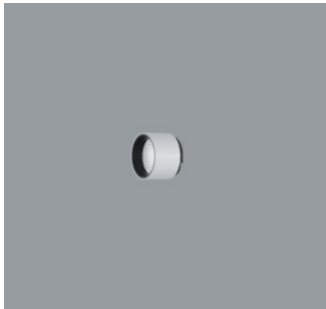

**AC002090**  
 Lens unit wallwash  
 Polymer, white, rotatable through 360°. Replacement without tools.  
 Spherolit lens made of optical polymer.

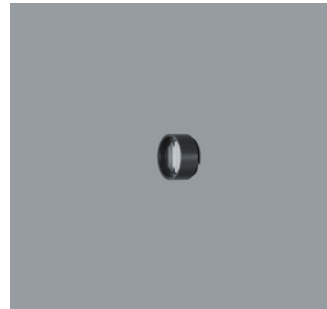

**AC006027**  
 Sculpture lens  
 Filter holder: polymer, black, rotatable through 360°. Replacement without tools.

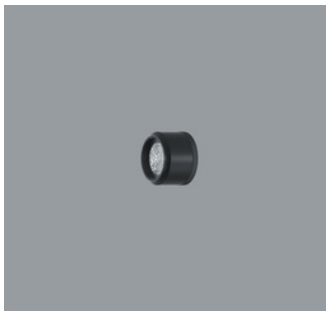

**AC002118**  
 Lens unit zoom spot  
 Polymer, black lacquered, rotatable through 360°. Replacement without tools.  
 Zoom lens made of optical polymer, infinitely variable focus.

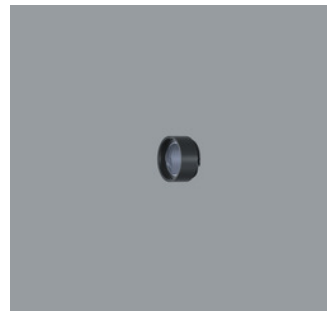

**AC006022**  
 Cold Filter  
 Filter holder: polymer, black, rotatable through 360°. Replacement without tools.



**AC002126**  
 Lens unit zoom spot  
 Polymer, white, rotatable through 360°. Replacement without tools.  
 Zoom lens made of optical polymer, infinitely variable focus.

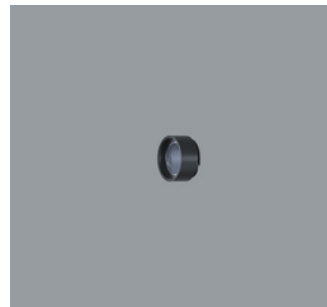

**AC006020**  
 Cold Filter Plus  
 Filter holder: polymer, black, rotatable through 360°. Replacement without tools.

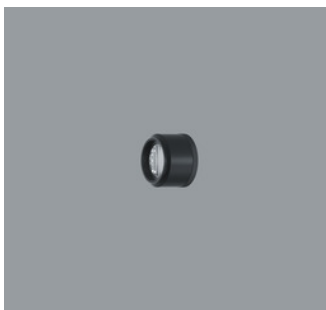

**AC002117**  
 Lens unit zoom oval  
 Polymer, black lacquered, rotatable through 360°. Replacement without tools.  
 Zoom lens made of optical polymer, infinitely variable focus.

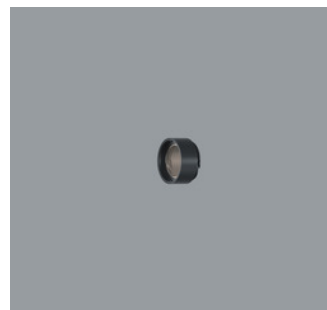

**AC006018**  
 Warm Filter  
 Filter holder: polymer, black, rotatable through 360°. Replacement without tools.



**AC002125**  
 Lens unit zoom oval  
 Polymer, white, rotatable through 360°. Replacement without tools.  
 Zoom lens made of optical polymer, infinitely variable focus.

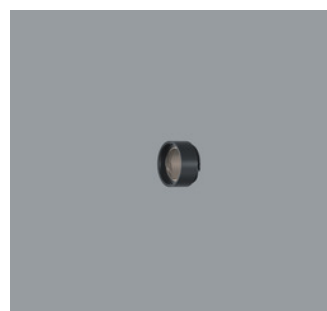

**AC006016**  
 Warm Filter Plus  
 Filter holder: polymer, black, rotatable through 360°. Replacement without tools.

## Accessories

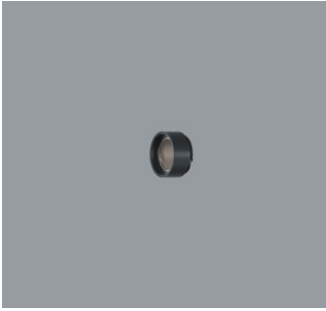

**AC006017**  
Skintone Filter  
Filter holder: polymer, black, rotatable through 360°. Replacement without tools.

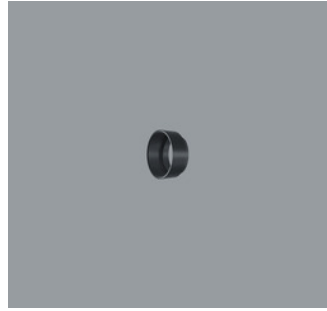

**AC001012**  
Snoot  
Polymer, black.

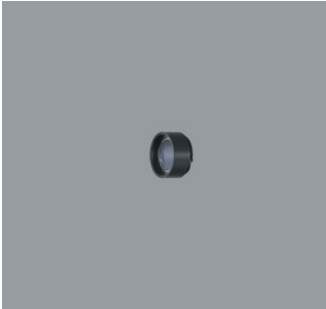

**AC006024**  
Fish Filter  
Filter holder: polymer, black, rotatable through 360°. Replacement without tools.



**AC004027**  
Honeycomb anti-glare screen  
Black

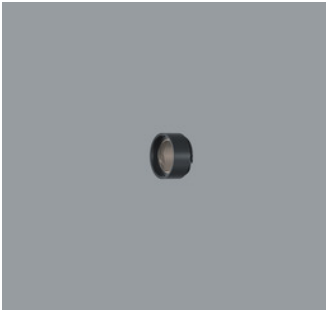

**AC006021**  
Marbled Meat Filter  
Filter holder: polymer, black, rotatable through 360°. Replacement without tools.

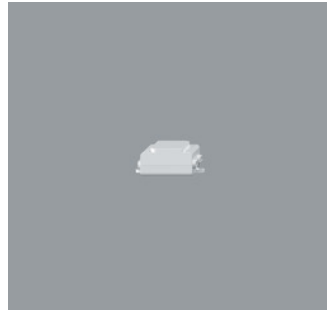

**AC007001**  
DALI Casambi Gateway  
Enables DALI systems to be connected to luminaires, sensors and control units with Casambi Bluetooth. The gateway can only be operated in Evolution networks. Power is supplied exclusively via the DALI bus. Connection via two lines which must be designed for mains voltage. The gateway requires no DALI addresses, the devices appear as non-configured devices in the DALI system. Addressing/commissioning is performed via the DALI control. It can individually control 64 devices, and via the broadcast command up to 249 devices.

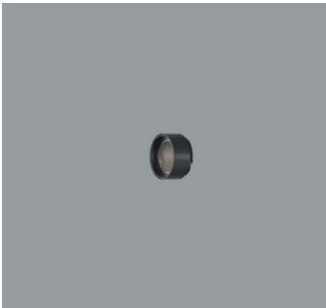

**AC006019**  
Bread and Pastry Filter  
Filter holder: polymer, black, rotatable through 360°. Replacement without tools.

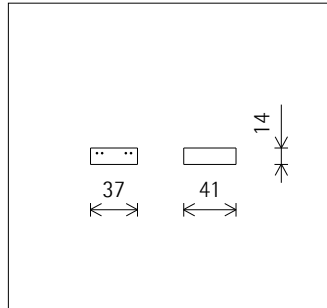

CE

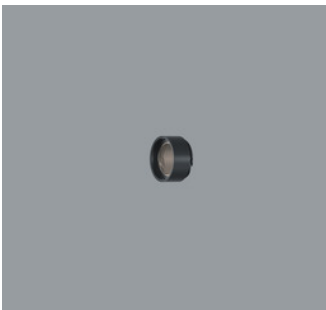

**AC006015**  
Blue Light Filter  
Filter holder: polymer, black, rotatable through 360°. Replacement without tools.



**55248.000**  
ERCO Casambi motion detector with light sensor for ERCO 220-240V track. Setup via Casambi app (Android/iOS) with Bluetooth Low Energy (BLE)-capable mobile devices. Use for daylight-dependent light control with or without motion detector. Detection range of infrared (PIR) sensor 100°/ 5m. At 3m room height, this is a circle with diameter of approx. 7m. 3-phase adapter for ERCO 220-240V track: plastic, white. White  
Weight 0.18kg

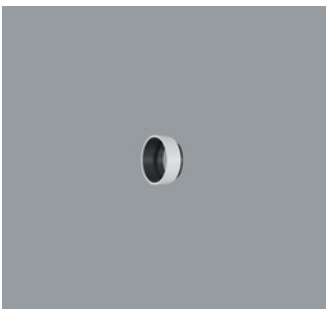

**AC001004**  
Snoot  
Polymer, black, coated white on outside.

CE

## Accessories

**55249.000**

ERCO Casambi motion detector with light sensor for ERCO 220-240V track.

Setup via Casambi app (Android/iOS) with Bluetooth Low Energy (BLE)-capable mobile devices.

Use for daylight-dependent light control with or without motion detector.

Detection range of infrared (PIR) sensor 100°/ 5m. At 3m room height, this is a circle with diameter of approx. 7m.

3-phase adapter for ERCO 220-240V track: polymer, black.

Black

Weight 0.18kg

