



## Jilly linear – The versatile light for modern work

### **An independent design for efficient and ergonomic light in offices**

Jilly pendant luminaires specialise in particularly efficient, standard-compliant lighting for office workplaces. As a pendant luminaire, Jilly offers complete freedom to arrange luminaires flexibly and at optimum height in the room. The elegant, flat housing and striking anti-glare louvers set Jilly apart from conventional office luminaires. Jilly's lighting technology combines a highly efficient lens system with an anti-dazzle louvre for visual comfort and luminous efficacy at

the same high level. Optionally, an integrated uplight provides diffuse upward light. In the tunable white version, Jilly also supports dynamic lighting concepts which bring the rhythm of daylight into the office.

## Jilly linear Pendant luminaires



### Structure and characteristics

The features described here are typical of products in this range. Special versions may offer additional or varying features. A comprehensive description of the features of individual products can be found on our website.

#### 1 ERCO lens system

- Made of optical polymer
- Light distributions: extra wide flood or oval wide flood

#### 2 ERCO LED-module

- Mid-power LEDs: warm white (2700K or 3000K), neutral white (3500K or 4000K) and tunable white (3000-6000K)

#### 3 Anti-dazzle louvre (light emission below)

- Polymer, black lacquered or aluminium vaporised, silver, mirror-finish

#### Diffuser (light emission upwards)

- Polymer, textured

#### 4 Housing

- White (RAL9002)
- Aluminium profile/polymer, powder-coated

#### 5 Control gear

- Switchable or DALI dimmable

#### 6 Suspensions

- Wire suspension with 1-point ceiling fixing and rapid wire connector for height compensation
- Ceiling fixture with canopy: metal/polymer, white

#### Variants on request

- Anti-glare louvre: gold matt, silver matt, champagne matt or copper matt-coated and other colours
  - Housing: 10,000 further colours
- Please contact your ERCO consultant.



Design and application:  
[www.erco.com/jilly-linear-pendant](http://www.erco.com/jilly-linear-pendant)

# Jilly linear Pendant luminaires



**Suitable for office workstations**  
 ERCO develops luminaires with the specifications of good glare control and high visual comfort. UGR values are used as support for purely norm-referenced lighting. With downlights though this should not be carried out using 'blanket' values, but should be implemented according to the individual arrangement of luminaires in the room.





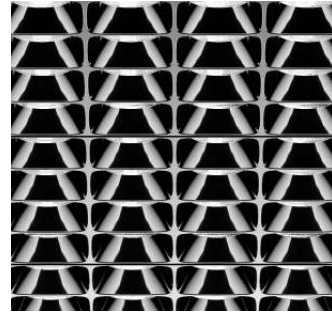



**Tunable white technology**  
 Just as the colour temperature outdoors changes continuously during the day, the colour temperature of indirect lighting can be adjusted indoors to e.g. support lighting concepts for Human Centric Lighting.







**Louvres for efficient visual comfort**  
 A louvre is designed to restrict the view into the luminaire, achieving efficient visual comfort with an emission angle of 90°. An anti-glare louvre available in black or silver enables the luminaire to blend with the material and colour of the ceiling.

**Special characteristics**

-  For office workstation lighting from UGR 13.8
-  Tunable white
-  Improved visual comfort

-  ERCO mid-power LEDs
-  Efficient lens system
-  Different light colours

-  Excellent thermal management
-  EMC-optimised

-  Switchable
-  DALI dimmable

# Jilly linear Pendant luminaires – Luminaire arrangement

## Pendant downlights Extra wide flood

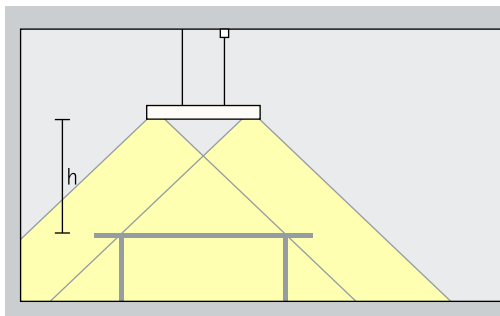

### General lighting

To achieve a high level of uniformity and good facial recognition when illuminating single workstations, Jilly pendant luminaires with extra wide flood light distribution should be suspended at a height (h) of approx. 1.2m above the desk plane.

Arrangement:  $h = 1,2$

Application area: illumination of desks, counters and conference tables

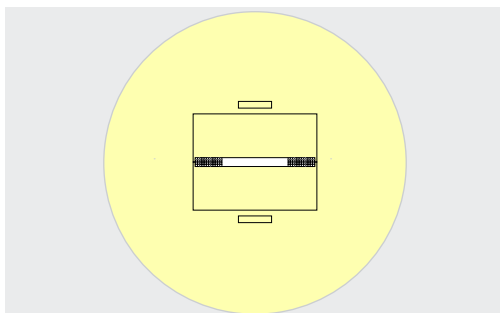

Jilly pendant luminaires with extra wide flood light distribution produce superb uniformity when arranged centrally above the table.

## Pendant downlights direct/indirect Extra wide flood

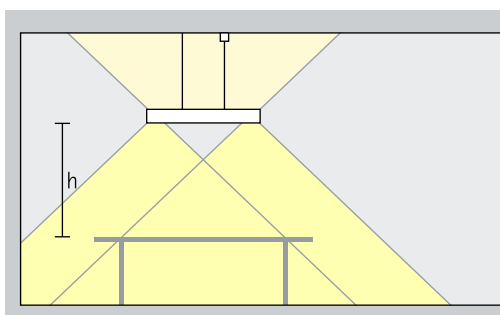

### General lighting

To achieve a high level of uniformity and good facial recognition when illuminating single workstations, Jilly pendant luminaires with extra wide flood light distribution should be suspended at a height (h) of approx. 1.2m above the desk plane.

Arrangement:  $h = 1,2$

Application area: illumination of desks, counters and conference tables

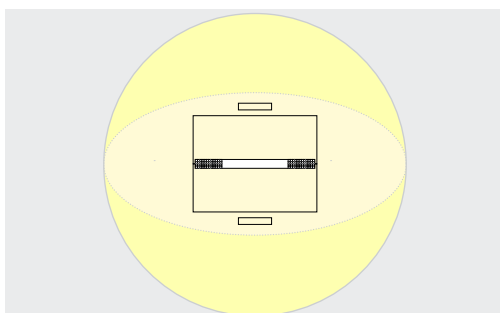

Jilly pendant luminaires with extra wide flood light distribution produce superb uniformity when arranged centrally above the table.

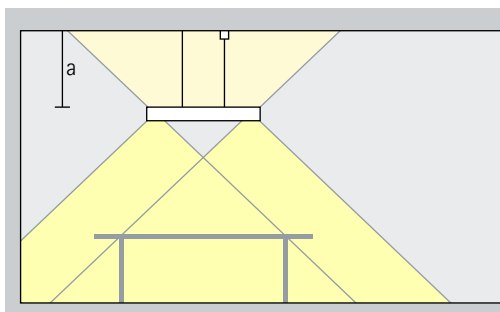

Indirect lighting on bright ceilings increases the visual comfort due to diffusely reflected light. The room also appears to be higher. The luminaire should be suspended from a height of at least 0.5m.

Arrangement:  $a \geq 0,5m$

# Jilly linear Pendant luminaires – Luminaire arrangement

## Pendant downlights oval wide flood

Oval wide flood

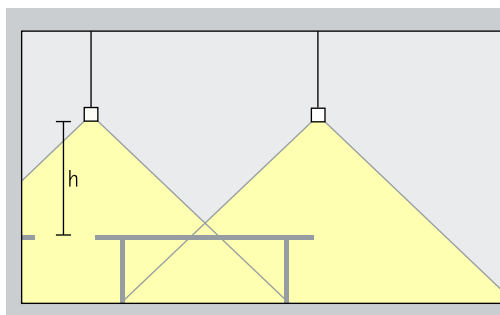

### General lighting

To achieve a high level of uniformity and good facial recognition when illuminating single workstations, Jilly pendant luminaires with oval wide flood light distribution should be suspended to the left and right of the desk at a height (h) of approx. 1.2m above the desk plane.

Arrangement:  $h = 1,2$

Application area: illumination of desks arranged side by side and wide conference tables.

## Pendant downlights oval wide flood direct/indirect

Oval wide flood

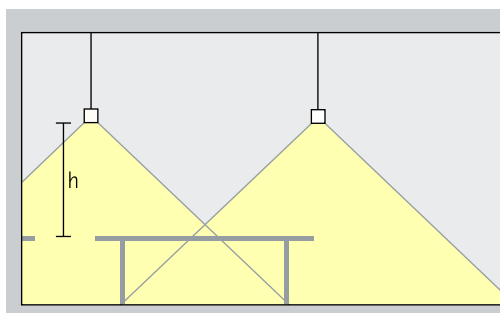

### General lighting

To achieve a high level of uniformity and good facial recognition when illuminating single workstations, Jilly pendant luminaires with oval wide flood light distribution should be suspended to the left and right of the desk at a height (h) of approx. 1.2m above the desk plane.

Arrangement:  $h = 1,2$

Application area: illumination of desks arranged side by side and wide conference tables.

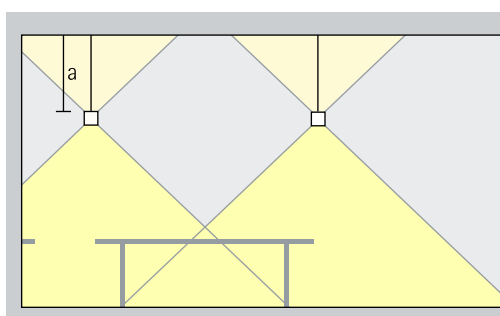

Indirect lighting on bright ceilings increases the visual comfort due to diffusely reflected light. The room also appears to be higher. The luminaire should be suspended from a height of at least 0.5m.

Arrangement:  $a \geq 0,5m$

# Jilly linear Pendant luminaires

Construction size 1500mm

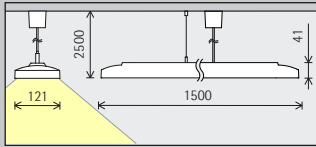

LED module  
Maximum value  
at 4000K CRI 82

24W/4490lm

Light colour  
(direct)

	2700K CRI 92		3500K CRI 92
	3000K CRI 82		4000K CRI 82
	3000K CRI 92		4000K CRI 92

Light  
distribution

Pendant downlights	Pendant downlights oval wide flood
Extra wide flood	Oval wide flood

Control

	Switchable
	DALI

Colour  
(housing/louvre)

	White/Silver		10,000 colours */ Silver
	White/Black		10,000 colours */ Black

Construction size

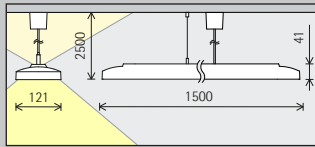

1500mm

LED module  
Maximum value  
at 4000K CRI 82

39W/7260lm

64W/8640lm

Light colour  
(direct)

	2700K CRI 92		3500K CRI 92
	3000K CRI 82		4000K CRI 82
	3000K CRI 92		4000K CRI 92

	2700K CRI 92		3500K CRI 92
	3000K CRI 82		4000K CRI 82
	3000K CRI 92		4000K CRI 92

Light colour  
(indirect)

	2700K CRI 92		3500K CRI 92
	3000K CRI 82		4000K CRI 82
	3000K CRI 92		4000K CRI 92

Tunable white

Light  
distribution

Pendant downlights	Pendant downlights oval wide flood
Extra wide flood	Oval wide flood

Pendant downlights	Pendant downlights oval wide flood
Extra wide flood	Oval wide flood

Control

	Switchable
	DALI

DALI

Colour  
(housing/louvre)

	White/Silver		10,000 colours */ Silver
	White/Black		110,000 colours */ Black

	White/Silver		10,000 colours */ Silver
	White/Black		10,000 colours */ Black

\* available on request

Article numbers and planning data:  
[www.erco.com/017796](http://www.erco.com/017796)

Design and application:  
[www.erco.com/jilly-linear-pendant](http://www.erco.com/jilly-linear-pendant)





