



Atrium double focus – Sophisticated light for high rooms

Versatile, high lumen-output lighting technology – for illumination from large heights

Atrium double-focus luminaires are especially suitable for high rooms, foyers, public buildings and sacred spaces. The cylindrical housing gains a striking design accent with the light-tight ventilation gap. Narrow downlight distributions generate precise lighting from large heights. The optional indirect component creates atmosphere and reduces contrasts. Their low weight allows them to be suspended via the power cord. All Atrium lumi-

nares are optionally available with black or silver anti-glare cone.

Atrium double focus Pendant luminaires

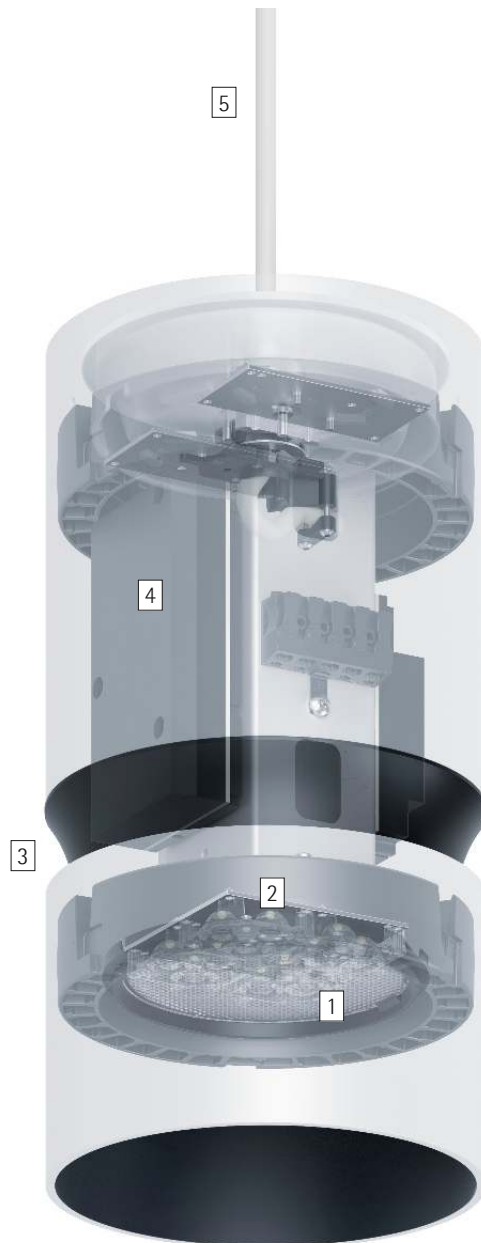

Structure and characteristics

The features described here are typical of products in this range. Special versions may offer additional or varying features. A comprehensive description of the features of individual products can be found on our website.

1 ERCO Spherolit lens (light emission below)

- Light distributions: flood or wide flood

Diffuser (light emission upwards)

- Polymer

2 ERCO LED-module

- High-power LEDs: warm white (2700K or 3000K) or neutral white (3500K or 4000K)
- Collimating lens made of optical polymer

3 Cylinder

- White (RAL9002), black or silver
- Aluminum profile, powder-coated, black or matt silver coated inside
- Cut-off angle 30° or 40° from horizontal
- Cone: polymer, black

4 Control gear

- 0-10V dimmable

5 Ceiling fixture with canopy

- White or black
- Connection cable with strain relief

Variants on request

- Housing: 10,000 further colors
- Please contact your ERCO consultant.



Design and application:
www.erco.com/atrium-df-pendant

Atrium double focus Pendant luminaires





Very high visual comfort
 ERCO has developed luminaires with special housing designs and high quality optical components specifically for demanding visual tasks to provide enhanced visual comfort.

Large lumen packages for very high illuminances
 The good glare control of the lens systems enables large lumen packages with high visual comfort.

Suitable for high rooms
 Theaters, atria and lecture halls are usually illuminated from the ceiling and therefore from a large height. Efficient lighting solutions for high rooms have luminaires that project the light precisely onto the surface to be illuminated, in this way avoiding spill light.

Special characteristics

-  Excellent visual comfort
-  Large lumen packages for very high illuminances
-  for high rooms



ERCO high-power LEDs



Efficient Spherolit technology



Cut-off 30°/40° from horizontal



Different light colors



Excellent thermal management



EMC-optimized



Various housing colors



Various construction sizes



0-10V dimmable

Atrium double focus Pendant luminaires – Luminaire arrangement

Pendant downlights
Flood, Wide flood

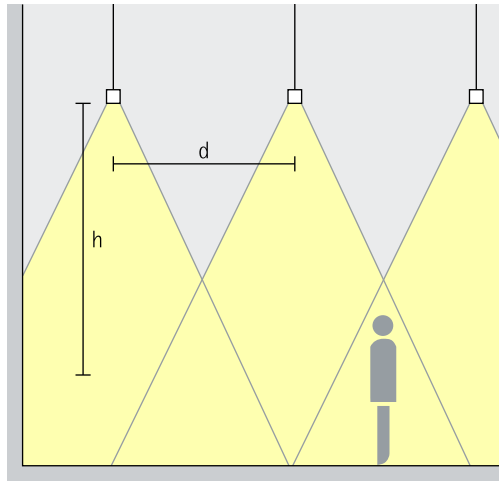

General lighting
For uniform general lighting, half the height (h) of the luminaire above the working plane can be used as the luminaire spacing (d) between two Atrium double focus pendant downlights (rough guide).

Arrangement: $d = h / 2$

Application area: rooms with high ceilings, e.g. foyers or event halls.

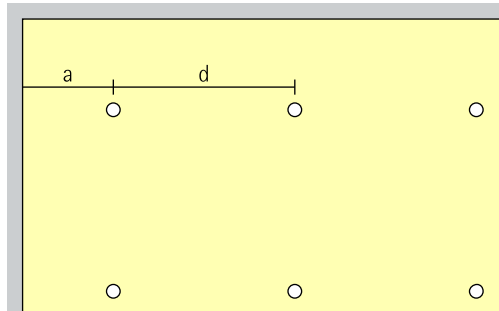

The recommended offset from the wall is half the luminaire spacing.

Arrangement: $a = d / 2$

Pendant downlights direct/indirect
Flood, Wide flood

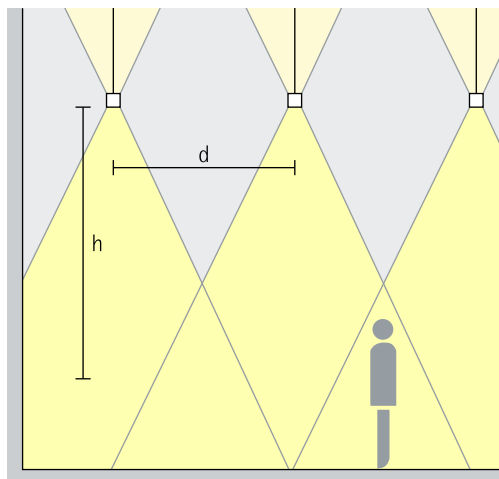

General lighting
For uniform general lighting, half the height (h) of the luminaire above the working plane can be used as the luminaire spacing (d) between two Atrium double focus pendant downlights (rough guide). Indirect lighting on the ceiling increases the visual comfort due to diffusely reflected light. The height of the room is also emphasized. The luminaire should be suspended from a height of at least 0.5m.

Arrangement: $d = h / 2$

Application area: rooms with high ceilings, e.g. foyers or event halls.

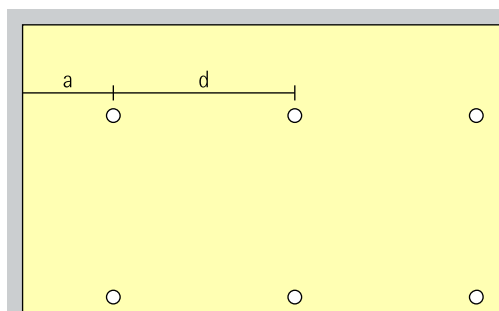

The recommended offset from the wall is half the luminaire spacing.

Arrangement: $a = d / 2$



Atrium double focus Pendant luminaires

Construction size

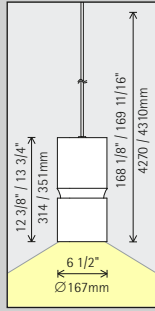

Size 5

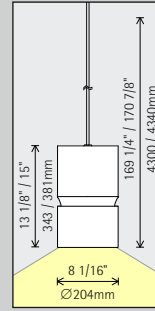

Size 7

LED module
Maximum value at 4000K CRI 82

24.2W/3259lm	37.1W/4583lm
--------------	--------------

48.3W/6518lm	74.1W/9166lm
--------------	--------------

Light color (direct)

	2700K CRI 92		3500K CRI 92
	3000K CRI 92		4000K CRI 82
	3000K CRI 97		4000K CRI 92

	2700K CRI 92		3500K CRI 92
	3000K CRI 92		4000K CRI 82
	3000K CRI 97		4000K CRI 92

Light distribution

Pendant downlights	
	Flood
	Wide flood

Pendant downlights	
	Flood
	Wide flood

Control

0-10V	0-10V
-------	-------

0-10V	0-10V
-------	-------

Color (housing)

	White		Silver matt
	Black		10,000 colors *

	White		Silver matt
	Black		10,000 colors *

Accessories

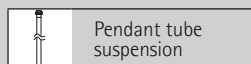

Construction size

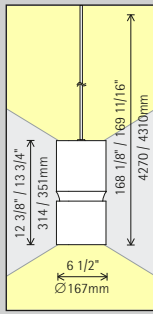

Size 5

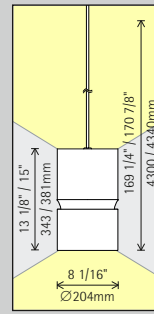

Size 7

LED performance class

36.3W/4889lm	55.6W/6874lm
--------------	--------------

72.5W/9777lm

Light color (direct)

	2700K CRI 92		3500K CRI 92
	3000K CRI 92		4000K CRI 82
	3000K CRI 97		4000K CRI 92

	2700K CRI 92		3500K CRI 92
	3000K CRI 92		4000K CRI 82
	3000K CRI 97		4000K CRI 92

Light color (indirect)

	2700K CRI 92		3500K CRI 92
	3000K CRI 92		4000K CRI 82
	3000K CRI 97		4000K CRI 92

	2700K CRI 92		3500K CRI 92
	3000K CRI 92		4000K CRI 82
	3000K CRI 97		4000K CRI 92

Light distribution

Pendant downlights	
	Flood
	Wide flood

Pendant downlights	
	Flood
	Wide flood

0-10V	0-10V
-------	-------

0-10V	0-10V
-------	-------

Color (housing)

	White		Silver matt
	Black		10,000 colors *

	White		Silver matt
	Black		10,000 colors *

* available on request

Article numbers and planning data:
www.erco.com/017686-us

Design and application:
www.erco.com/atrium-df-pendant

