



Uniscan InTrack – A minimalist and multi-talented

The specialist for galleries with flush-track adapter

Compact, flexible and easy to handle: Uniscan brings maximum quality of light to sophisticated art galleries and museums. The neutral, cylindrical shape blends into spaces of all styles and the Intrack adapter nestles flush into the track. Adaptability is a key feature of Uniscan, because every exhibition needs different light. Light distributions can be changed at any time thanks to the interchangeable lens units. The darklight lenses give the Uniscan spotlights a magical appearance. Tunable white and wireless con-

trol via Casambi Bluetooth make it possible to interactively design with light colours and dimming values. Further dimming options and interfaces with interchangeable control units ensure future-proof connectivity.

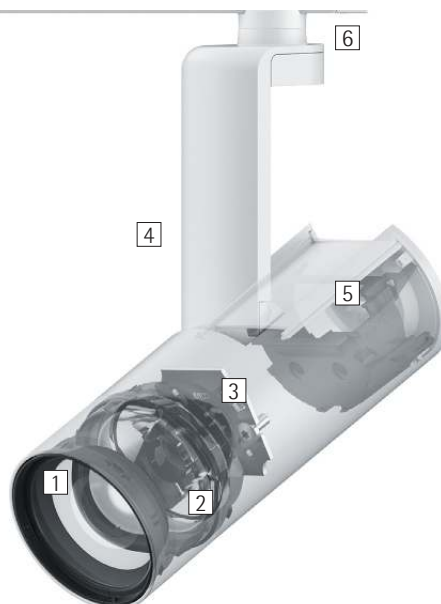

Structure and characteristics

The features described here are typical of products in this range. Special versions may offer additional or varying features. A comprehensive description of the features of individual products can be found on our website.

1 ERCO lenses

- Made of optical polymer
- Darklight lenses: narrow spot, spot, flood, wide flood or extra wide flood
- Spherolit lenses: oval flood, oval wide flood or wallwash
- Zoom lenses: zoom spot or zoom oval; continuously focusable
- Projection lenses: narrow framing or wide framing; continuously focusable

2 Lens unit

- Rotatable through 360°
- Polymer, white or black
- Contour spotlights with framing attachment

3 ERCO LED-module

- High-power LEDs: warm white (2700K or 3000K), neutral white (3500K or 4000K), tunable white (2700-7500K) or RGBW
- Collimating lens made of optical polymer

4 Housing and bracket

- White (RAL9002), black or silver
- Die cast zinc or cast aluminium, powder-coated
- Pivotal 0°-90°
- Bracket: cast aluminium/polymer; rotatable through 360° on adapter

5 Control gear

- On-board Dim, Multi Dim, Multi Dim+On-board Dim, Casambi Bluetooth or Zigbee
- Multi Dim version: DALI dimmable, Push Dim or dimming with external dimmers (leading edge-/trailing edge-/ universal dimmer) possible
- On-board Dim version: rotary control for control of brightness on the luminaire

6 ERCO Intrack adapter

Variants on request

- Housing: 10,000 further colours
- Please contact your ERCO consultant.



Design and application:
www.erco.com/uniscan-intrack

Uniscan InTrack for track 220-240V



Darklight lens
The Darklight lens not only creates a magical impression with just one light point. It also features precise, uniform light distributions, wide flexibility in the selection of beam characteristics and state of the art efficiency.



Contour spotlights
Framing attachments enable a sharply defined light beam. In this way fascinating effects can be created with contour spotlights, where crisply illuminated pictures appear to illuminate from within.

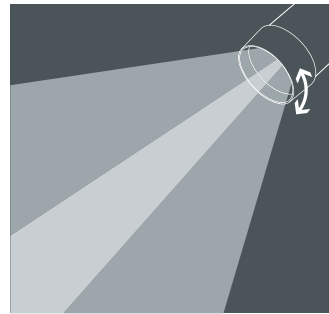

Zoom spotlights
The light beam diameter can be infinitely adjusted from spot (15°) to wide flood (65°) by simply turning the lens. Zoom spotlights are particularly suitable for illuminating areas with changing exhibits and merchandise.



Coloured light
Using coloured light, the environment can be designed and transformed with either subtle or dramatic contrasts. LEDs enable you to generate coloured light very efficiently and flexibly.



Tunable white technology
Just as the colour temperature outdoors changes continuously during the day, the colour temperature of the lighting can be adjusted indoors to e.g. support lighting concepts for Human Centric Lighting.

Special characteristics



Efficient darklight technology



Contour spotlight



Zoom spotlight



Coloured light



Tunable white



ERCO high-power LEDs



Optical cut-off 40°/50°/60°



Different light distributions



Oval flood, freely rotatable



Different light colours



Excellent thermal management



EMC-optimised



Various housing colours



Various construction sizes



Pivotable through 90°



Accessory for maximum visual comfort



On-board Dim



Multi Dim



Multi Dim + On-board Dim



Casambi Bluetooth



Zigbee

Uniscan InTrack for track 220-240V – Luminaire arrangement

Spotlights

Narrow spot, Spot, Flood

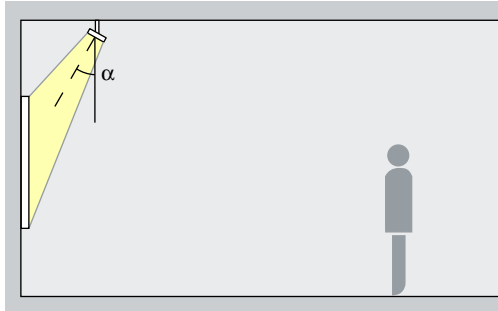

Accentuation

Works of art, merchandise and architectural details are effectively accentuated with Uniscan. The ideal angle of tilt (α) for this is around 30° . The object is modelled without distorting the effect as a result of excessive shadowing. It also prevents shadows cast by the observer.

Arrangement: $\alpha = 30^\circ$

Zoom spotlights

Zoom spot, Zoom oval

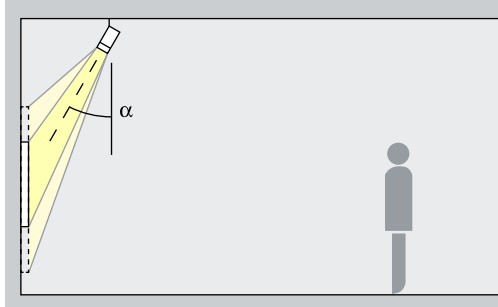

Accentuation

Zoom spotlights feature a continuously adjustable beam angle. With the spot to wide flood zoom range, smaller works of art can be accentuated effectively at an inclination angle (α) of approximately 30° . The oval zoom is suitable for linear works of art. The object is modelled without distorting the effect as a result of excessive shadowing. It also prevents shadows cast by the observer.

Arrangement: $\alpha = 30^\circ$

Contour spotlights

Narrow framing, Wide framing

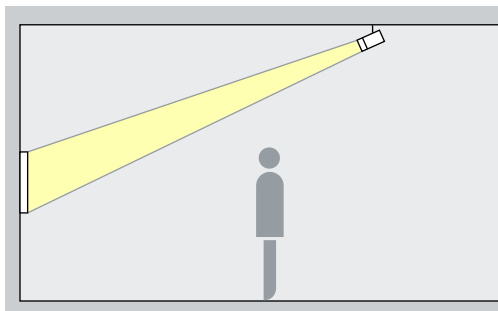

Projection

Contour spotlights generate freely adjustable, crisp-edged light beams. As a result fascinating effects can be created where pictures appear to illuminate from within. Select narrow framing to accurately illuminate small exhibits from a long distance and wide framing to accurately illuminate large exhibits from a short distance.

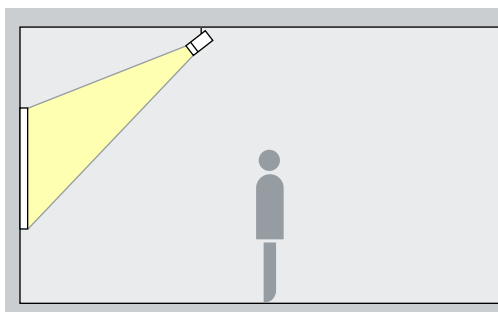

Floodlights

Wide flood, Extra wide flood, Oval wide flood, Oval flood

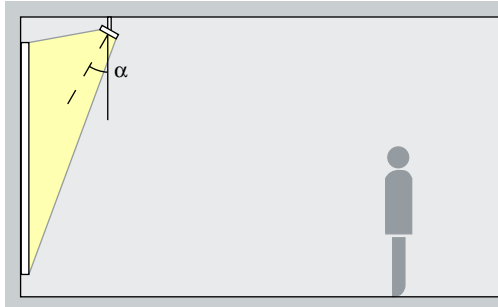

Washlighting

The ideal angle of tilt (α) for floodlighting objects with a long, square shape, e.g. pictures, sculptures or merchandise displays, is around 30° .

Arrangement: $\alpha = 30^\circ$

Uniscan InTrack for track 220-240V – Luminaire arrangement

Lens wallwashers
Wallwash

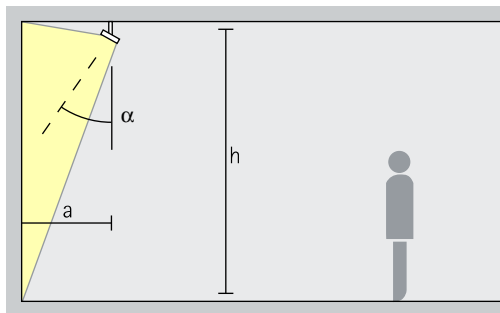

Wallwashing

For uniform vertical lighting, the distance to the wall (a) of Uniscan lens wallwashers should be around one third of the room height (h). This results in an angle of tilt (α) of approx. 35°.

Arrangement: $a = 1/3 \times h$ or $\alpha = 35^\circ$

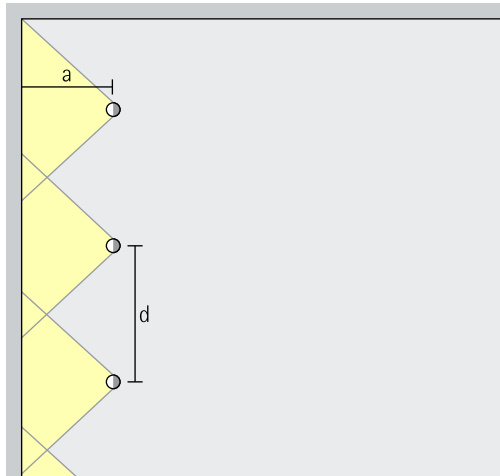

For good longitudinal uniformity, the spacing (d) of Uniscan lens wallwashers may be up to 1.2 times the distance to the wall (a).

Arrangement: $d \leq 1.2 \times a$

Optimal wall distances and luminaire spacing values for individual products are specified in the wall-washer tables at www.erco.com.

Uniscan InTrack for track 220-240V

Size

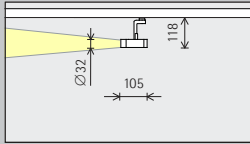

XS
Ø 32mm

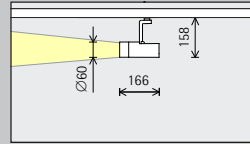

S
Ø 60mm

LED module Maximum value at 4000K CRI 82

2W/262lm	3.1W/369lm (Narrow spot)
3.1W/369lm	

8.1W/1048lm	3.1W/369lm (Narrow spot)
12.4W/1476lm	

Light colour

	2700K CRI 92		3500K CRI 92
	3000K CRI 92		4000K CRI 82
	3000K CRI 97		4000K CRI 92

	2700K CRI 92		3500K CRI 92
	3000K CRI 92		4000K CRI 82
	3000K CRI 97		4000K CRI 92

Light distribution

Spotlights	Floodlights
Narrow spot	Wide flood
Spot	Extra wide flood
Flood	Oval flood
Zoom spotlights	Oval wide flood
Zoom spot	Lens wallwashers
Zoom oval	Wallwash

Spotlights	Floodlights
Narrow spot	Wide flood
Spot	Extra wide flood
Flood	Oval flood
Zoom spotlights	Oval wide flood
Zoom spot	Lens wallwashers
Zoom oval	Wallwash
Contour spotlights	
Narrow framing	
Wide framing	

Control

Casambi Bluetooth + DALI via Gateway	Zigbee
Multi Dim ✓ DALI dimmable ✓ Push Dim ✓ Phase dimmable	Multi Dim + On-board Dim ✓ DALI dimmable ✓ Push Dim ✓ Phase dimmable ✓ Dimmable via rotary control
On-board Dim	

Casambi Bluetooth + DALI via Gateway	Zigbee
Multi Dim ✓ DALI dimmable ✓ Push Dim ✓ Phase dimmable	Multi Dim + On-board Dim ✓ DALI dimmable ✓ Push Dim ✓ Phase dimmable ✓ Dimmable via rotary control
On-board Dim	

Colour (housing)

	White		Silver
	Black		10,000 colours *

	White		Silver
	Black		10,000 colours *

Accessory

	Lenses		Lens Units		Snoot		Add-on Control Units
	Filter		Honeycomb louvre		Barn doors		DALI Casambi Gateway

5.8W/695lm

Tunable white

Spotlights	Floodlights
Spot	Wide flood
Flood	Extra wide flood
Zoom spotlights	Oval flood
Zoom spot	Oval wide flood
Zoom oval	Lens wallwashers
Contour spotlights	Wallwash
Narrow framing	
Wide framing	

Casambi Bluetooth + DALI via Gateway	Zigbee
Multi Dim ✓ DALI dimmable ✓ Push Dim ✓ Phase dimmable	Multi Dim + On-board Dim ✓ DALI dimmable ✓ Push Dim ✓ Phase dimmable ✓ Dimmable via ✓ rotary control

White	Silver
Black	10,000 colours *

9.3W/801lm

RGBW

Spotlights	Floodlights
Spot	Wide flood
Flood	Extra wide flood
Zoom spotlights	Oval flood
Zoom spot	Oval wide flood
Zoom oval	Lens wallwashers
Contour spotlights	Wallwash
Narrow framing	
Wide framing	

Casambi Bluetooth + DALI via Gateway	Zigbee
Multi Dim ✓ DALI dimmable ✓ Push Dim ✓ Phase dimmable	Multi Dim + On-board Dim ✓ DALI dimmable ✓ Push Dim ✓ Phase dimmable ✓ Dimmable via ✓ rotary control

White	Silver
Black	10,000 colours *

* available on request

Article numbers and planning data:
www.erco.com/022634

Design and application:
www.erco.com/uniscan-intrack



Uniscan InTrack for track 220-240V

Size

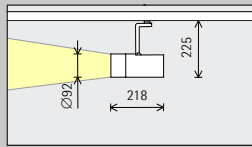

M
Ø 92mm

LED module Maximum value at 4000K CRI 82

14.1W/1843lm	4.2W/464lm (Narrow spot)
21.7W/2582lm	

18.3W/2154lm

Light colour

	2700K CRI 92		3500K CRI 92
	3000K CRI 92		4000K CRI 82
	3000K CRI 97		4000K CRI 92

	Tunable white
--	---------------

Light distribution

Spotlights	Floodlights
Narrow spot	Wide flood
Spot	Extra wide flood
Flood	Oval flood
Zoom spotlights	Oval wide flood
Zoom spot	Lens wallwashers
Zoom oval	Wallwash
Contour spotlights	
Narrow framing	
Wide framing	

Spotlights	Floodlights
Spot	Wide flood
Flood	Extra wide flood
Zoom spotlights	Oval flood
Zoom spot	Oval wide flood
Zoom oval	Lens wallwashers
Contour spotlights	Wallwash
Narrow framing	
Wide framing	

Control

Casambi Bluetooth + DALI via Gateway	Zigbee
MULTI Multi Dim ✓ DALI dimmable ✓ Push Dim ✓ Phase dimmable	MULTI+ Multi Dim + On-board Dim ✓ DALI dimmable ✓ Push Dim ✓ Phase dimmable ✓ Dimmable via ✓ rotary control
On-board Dim	

Casambi Bluetooth + DALI via Gateway	Zigbee
MULTI Multi Dim ✓ DALI dimmable ✓ Push Dim ✓ Phase dimmable	MULTI+ Multi Dim + On-board Dim ✓ DALI dimmable ✓ Push Dim ✓ Phase dimmable ✓ Dimmable via ✓ rotary control

Colour (housing)

	White		Silver
	Black		10,000 colours *











	White		Silver
	Black		10,000 colours *





Accessory





	Lenses		Lens Units		Snoot		Add-on Control Units
	Filter		Honeycomb louvre		Barn doors		DALI Casambi Gateway

17.7W/1520lm

 RGBW

Spotlights	Floodlights
 Spot	 Wide flood
 Flood	 Extra wide flood
Zoom spotlights	 Oval flood
 Zoom spot	 Oval wide flood
 Zoom oval	Lens wallwashers
Contour spotlights	 Wallwash
 Narrow framing	
 Wide framing	

 Casambi Bluetooth + DALI via Gateway	 Zigbee
 Multi Dim ✓ DALI dimmable ✓ Push Dim ✓ Phase dimmable	 Multi Dim + On-board Dim ✓ DALI dimmable ✓ Push Dim ✓ Phase dimmable ✓ Dimmable via ✓ rotary control

 White	 Silver
 Black	 10,000 colours *

* available on request

Article numbers and planning data:
www.erco.com/022634

Design and application:
www.erco.com/uniscan-intrack



