



Quintessence round – The system solution for excellent visual comfort

Large luminaire spacing, high uniformity and excellent visual comfort

Quintessence sets standards in terms of visual comfort, efficiency and quality of light for recessed luminaires. The product range consists of downlights, lens wallwashers and directional spotlights. Characteristic of Quintessence downlights and lens wallwashers are their good glare control and high uniformity of illumination. The 90° beam angle and a 40° shielding angle allow wide luminaire spacing for efficient general lighting.

Quintessence round Recessed luminaires

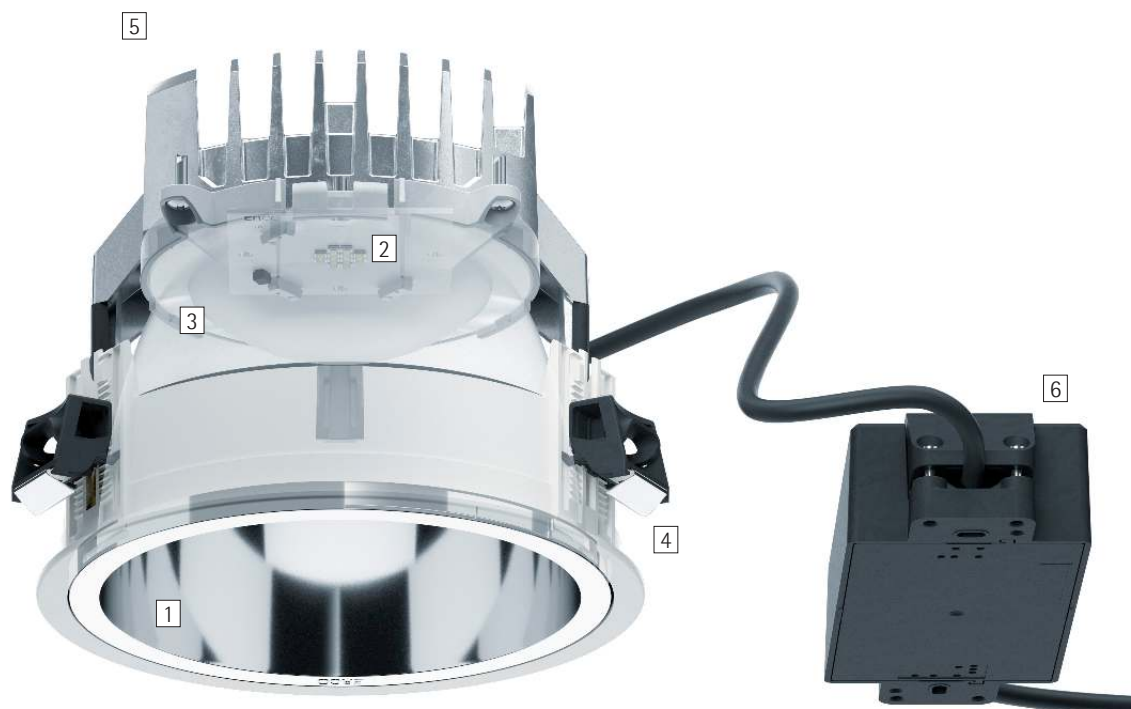

Structure and characteristics

The features described here are typical of products in this range. Special versions may offer additional or varying features. A comprehensive description of the features of individual products can be found on our website.

1 ERCO darklight reflector

- Downlight: cut-off angle 40° from horizontal
- Polymer, aluminum vaporized, specular

or

Wallwasher reflector

- Cut-off angle 80° from horizontal
- Polymer, aluminum vaporized, specular

2 ERCO LED module

- High-power LEDs: warm white (2700K or 3000K) or neutral white (3500K or 4000K)
- Directional luminaire with collimating lens made of optical polymer

3 Diffuser or lens

- Made of optical polymer
- Diffuser lens, wide flood, extra wide flood or lens system, wallwash
- Directional luminaire with Spherolit lens narrow spot, spot or flood

4 Mounting ring

- Covered mounting detail
- Fixing for ceiling thicknesses of 1-25mm (size 3-4) or 1-30mm (size 5-7)
- Polymer, white
- For flush mounting: mounting ring to be ordered separately, fixing for ceiling thicknesses of 1/2" - 1" / 12.5-25mm

5 Housing

- Cast aluminum, designed as heat sink
- Rotatable through 360°
- Fixing ring: polymer, black
- Fixing of the beam direction
- Directional luminaire: 0°-30° tilt. Lockable angles of tilt and rotation

6 Control gear

- Switchable, trailing edge dimmable or 0-10V dimmable
- Trailing edge dimmable version:**
- Operation at 120V: Dimming with external dimmers possible

Variants on request

- Reflector: coated matt gold, matt silver or matt champagne
- Mounting ring: 10,000 further colors
- Control: Lutron

Please contact your ERCO consultant.



Design and application:
www.erco.com/quintessence-round

Quintessence round Recessed luminaires





Very high visual comfort
The darklight reflector combines maximum visual comfort with an optimum light output ratio.













Suitable for office workstations
ERCO develops luminaires with the specifications of good glare control and high visual comfort. UGR values are used as support for purely norm-referenced lighting. With downlights though this should not be carried out using 'blanket' values, but should be implemented according to the individual arrangement of luminaires in the room.





Covered or flush mounting detail
As standard, all recessed luminaires have overlapping installation details. Flush mounting rings are available as accessories.

Special characteristics	
	Excellent visual comfort
	For office workstation lighting as of UGR 18.9
	Flush or covered mounting detail

	ERCO high-power LEDs
	Efficient Spherolit technology
	Cut-off 40°/80° from horizontal
	Different light distributions
	Different light colors

	Excellent thermal management
	EMC-optimized
	Various construction sizes
	Lockable
	Tool-free mounting

	Switchable
	Trailing edge dimmable
	0-10V dimmable

Quintessence round Recessed luminaires – Luminaire arrangement

Downlights

Wide flood, Extra wide flood

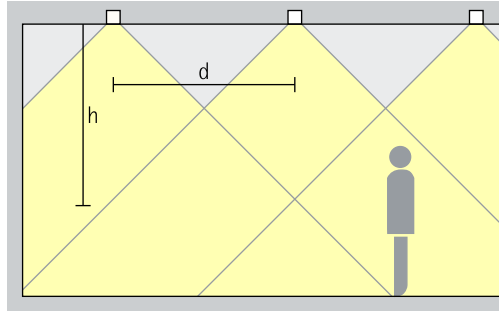

General lighting

For uniform ambient lighting with high visual comfort, the spacing (d) between two Quintessence downlights may be up to approximately 1.5 times the height (h) of the luminaire above the working plane.

Arrangement: $d \leq 1.5 \times h$

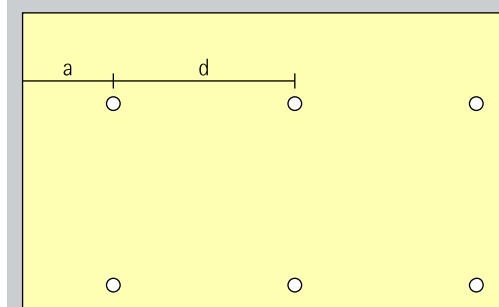

The wall offset should be half the luminaire spacing.

Arrangement: $a = d / 2$

Lens wallwashers

Wallwash

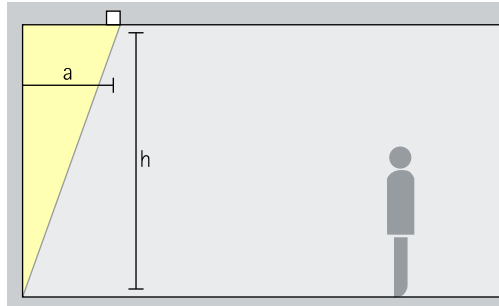

Wallwashing

For uniform vertical illuminance, the distance (a) of Quintessence lens wallwashers from the wall should be around one third of the room height (h).

Arrangement: $a = 1/3 \times h$

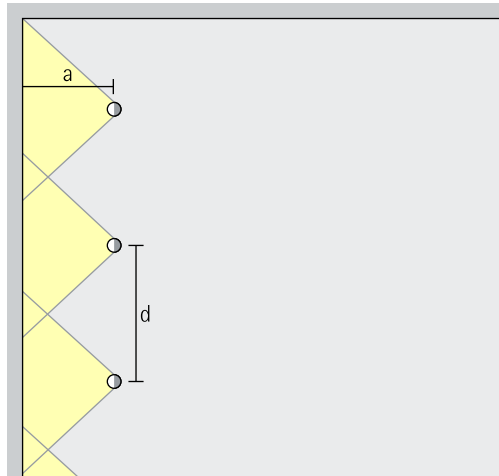

For good longitudinal uniformity, the spacing (d) of Quintessence lens wallwashers may be up to 1.3 times the offset from the wall (a).

Arrangement: $d \leq 1.3 \times a$

The optimal wall offset and luminaire spacing for each product are indicated in the wallwasher tables in the catalogue and the product data sheets.

Directional luminaires

Narrow spot, Spot, Flood

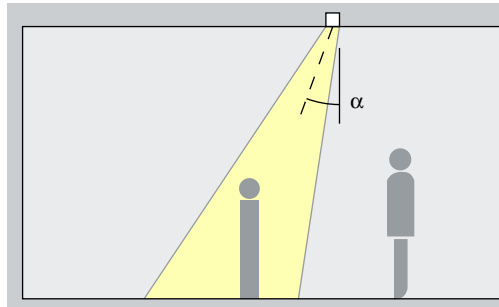

Accentuation

Quintessence directional luminaires accentuate artwork, products and architectural details effectively. The ideal angle of tilt (α) for this is around 30°. The object is modelled without distorting the effect as a result of excessive shadowing. It also prevents shadows cast by the observer.

Arrangement: $\alpha = 30^\circ$

The Shrine of our Lady Rosary of NamYang, South Korea. Architect: Mario Botta, Mendrisio. Lighting design: bitzro & partners, Seoul. Photography: Efrain Mendez Tabares, Spain



Quintessence round Recessed luminaires

Construction size

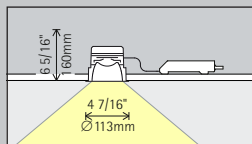

Size 3

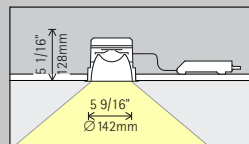

Size 4

LED module Maximum value at 4000K CRI 82

12.1W/1572lm	2W/262lm (Narrow spot)
--------------	------------------------

18.2W/2358lm	3.1W/369lm (Narrow spot)
--------------	--------------------------

Light color

	2700K CRI 92		3500K CRI 92
	3000K CRI 92		4000K CRI 82
	3000K CRI 97		4000K CRI 92

	2700K CRI 92		3500K CRI 92
	3000K CRI 92		4000K CRI 82
	3000K CRI 97		4000K CRI 92

Light distribution

Downlights		Directional luminaires	
	Wide flood		Narrow spot
	Extra wide flood		Spot
	Lens wallwashers		Flood
	Wallwash		

Downlights		Directional luminaires	
	Wide flood		Narrow spot
	Extra wide flood		Spot
	Lens wallwashers		Flood
	Wallwash		

Control

	Switchable
	Trailing edge dimmable
0-10V	0-10V

	Switchable
	Trailing edge dimmable
0-10V	0-10V

Accessories

	Junction box		Mounting ring
	Flexible metal conduit		Cover ring
	Plaster frame		
	Ultra airtight I.C. box		

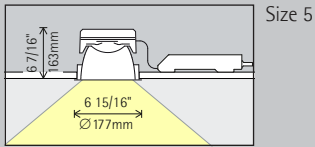

Size 5

24.3W/3144lm	6.1W/786lm (Narrow spot)
--------------	--------------------------

	2700K CRI 92		3500K CRI 92
	3000K CRI 92		4000K CRI 82
	3000K CRI 97		4000K CRI 92

Downlights		Directional luminaires	
	Wide flood		Narrow spot
	Extra wide flood		Spot
	Lens wallwashers		Flood
	Wallwash		

	Switchable
	Trailing edge dimmable
0-10V	0-10V

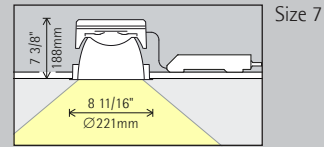

Size 7

32.3W/4192lm	8.1W/1048lm (Narrow spot)
--------------	---------------------------

	2700K CRI 92		3500K CRI 92
	3000K CRI 92		4000K CRI 82
	3000K CRI 97		4000K CRI 92

Downlights		Directional luminaires	
	Wide flood		Narrow spot
	Extra wide flood		Spot
	Lens wallwashers		Flood
	Wallwash		

	Switchable
	Trailing edge dimmable
0-10V	0-10V

Article numbers and planning data:
www.erco.com/014091-us

Design and application:
www.erco.com/quintessence-round



