



## Atrium double focus – Sophisticated light for high rooms

**Versatile, high lumen-output lighting technology – for illumination from large heights**

Atrium double-focus luminaires are especially suitable for high rooms, foyers, public buildings and sacred spaces. The cylindrical housing gains a striking design accent with the light-tight ventilation gap. Narrow downlight distributions generate precise lighting from large heights. The optional indirect component creates atmosphere and reduces contrasts. Their low weight allows them to be suspended via the power cable. All Atrium luminaires are available as an option

with black or silver anti-glare cone. The in-house developed control gear provides uniform operating behaviour of luminaire groups and dimming values down to 0.1% via DALI.

## Atrium double focus Pendant luminaires

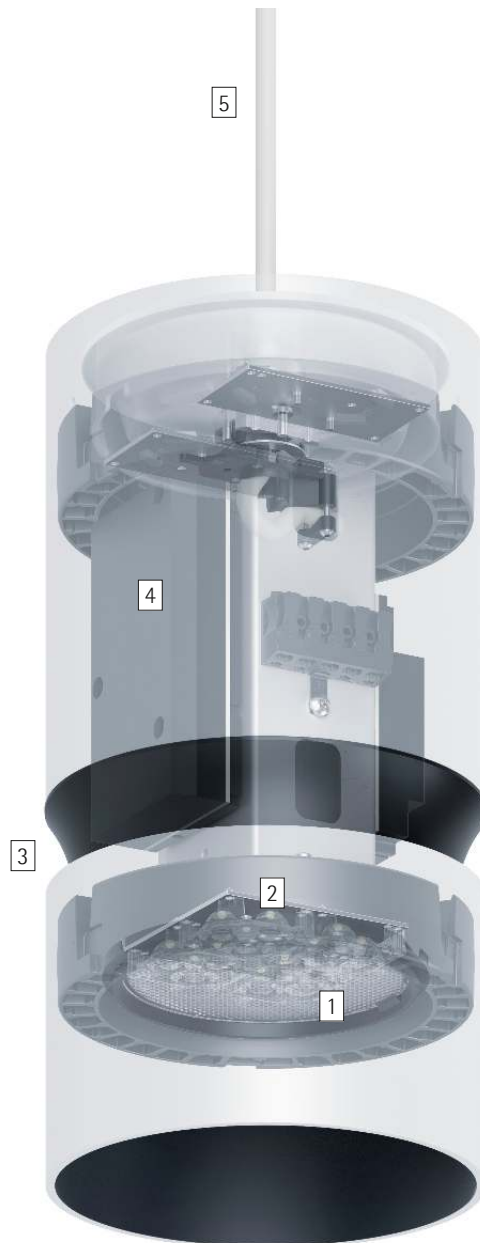

### Structure and characteristics

The features described here are typical of products in this range. Special versions may offer additional or varying features. A comprehensive description of the features of individual products can be found on our website.

#### 1 ERCO Spherolit lens (light emission below)

- Light distributions: flood or wide flood

#### Diffuser (light emission upwards)

- Polymer

#### 2 ERCO LED-module

- High-power LEDs: warm white (2700K or 3000K) or neutral white (3500K or 4000K)
- Collimating lens made of optical polymer

#### 3 Cylinder

- White (RAL9002) or black
- Aluminium profile, powder-coated, black or matt silver coated inside
- Cut-off angle 30° or 40°
- Cone: polymer, black

#### 4 Control gear

- Switchable, phase dimmable or DALI dimmable
- Phase dimmable version: Dimming with external dimmers possible (trailing edge)

#### 5 Ceiling fixture with canopy

- White or black
- Connection cable with strain relief

#### Variants on request

- Housing: 10,000 further colours
- Please contact your ERCO consultant.



Design and application:  
[www.erco.com/atrium-df-pendant](http://www.erco.com/atrium-df-pendant)

# Atrium double focus Pendant luminaires









**Very high visual comfort**  
 ERCO has developed luminaires with special housing designs and high quality optical components specifically for demanding visual tasks to provide enhanced visual comfort.





**Large lumen packages for very high illuminances**  
 The good glare control of the lens systems enables large lumen packages with high visual comfort.



**Suitable for high rooms**  
 Theatres, atria and lecture halls are usually illuminated from the ceiling and therefore from a large height. Efficient lighting solutions for high rooms have luminaires that project the light precisely onto the surface to be illuminated, in this way avoiding spill light.

**Special characteristics**

-  Excellent visual comfort
-  Large lumen packages for very high illuminances
-  for high rooms

-  ERCO high-power LEDs
-  Efficient Spherolit technology
-  Cut-off 30°/40°
-  Different light colours

-  Excellent thermal management
-  EMC-optimised
-  Various housing colours
-  Various construction sizes

-  Switchable
-  Phase dimmable
-  DALI dimmable

# Atrium double focus Pendant luminaires – Luminaire arrangement

## Pendant downlights Flood, Wide flood

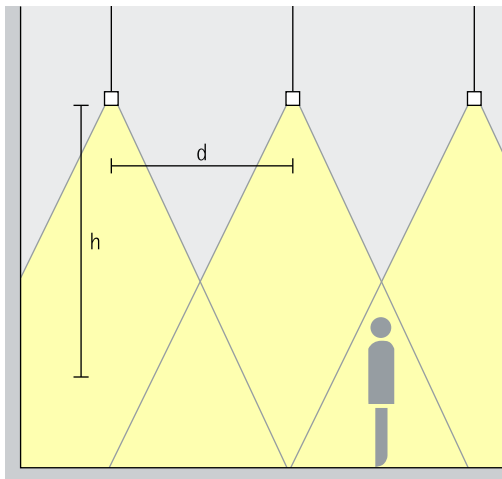

For uniform general lighting, half the height (h) of the luminaire above the working plane can be used as the luminaire spacing (d) between two Atrium double focus pendant downlights (rough guide).

Arrangement:  $d = h / 2$

Application area: rooms with high ceilings, e.g. foyers or event halls.

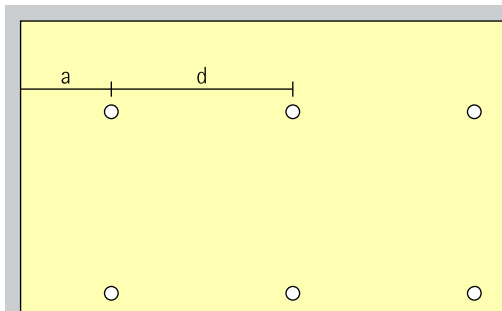

The recommended offset from the wall is half the luminaire spacing.

Arrangement:  $a = d / 2$

## Pendant downlights direct/indirect Flood, Wide flood

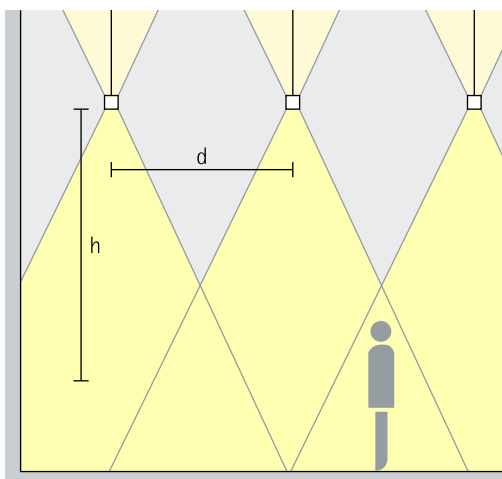

For uniform general lighting, half the height (h) of the luminaire above the working plane can be used as the luminaire spacing (d) between two Atrium double focus pendant downlights (rough guide). Indirect lighting on the ceiling increases the visual comfort due to diffusely reflected light. The height of the room is also emphasised. The luminaire should be suspended from a height of at least 0.5m.

Arrangement:  $d = h / 2$

Application area: rooms with high ceilings, e.g. foyers or event halls.

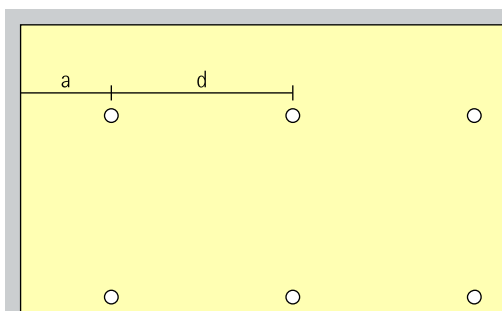

The recommended offset from the wall is half the luminaire spacing.

Arrangement:  $a = d / 2$



# Atrium double focus Pendant luminaires

Construction size

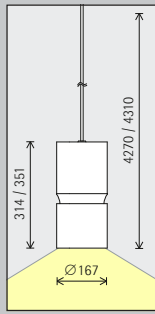

Size 5

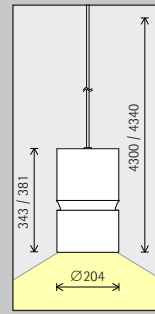

Size 7

LED module  
Maximum value  
at 4000K CRI 92

24.3W/3446lm	37.3W/4853lm
--------------	--------------

48.5W/6893lm	74.6W/9706lm
--------------	--------------

Light colour  
(direct)

	2700K CRI 92		3500K CRI 92
	3000K CRI 92		4000K CRI 92
	3000K CRI 97		

	2700K CRI 92		3500K CRI 92
	3000K CRI 92		4000K CRI 92
	3000K CRI 97		

Light  
distribution

Pendant downlights	
	Flood
	Wide flood

Pendant downlights	
	Flood
	Wide flood

Control

	Switchable
	Phase dimmable
	DALI

	Switchable
	Phase dimmable
	DALI

Colour (housing)

	White		10,000 colours *
	Black		

	White		10,000 colours *
	Black		

Colour  
(anti-glare cone)

	Silver matt		10,000 colours *
	Black		

	Silver matt		10,000 colours *
	Black		

Accessories

	Pendant tube suspension
--	-------------------------

Construction size

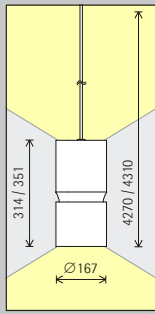

Size 5

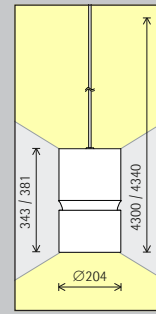

Size 7

LED module  
Maximum value  
at 4000K CRI 92

36.4W/5169lm	55.9W/7279lm
--------------	--------------

72.8W/10339lm	111.9W/14559lm
---------------	----------------

Light colour  
(direct and indirect)

	2700K CRI 92		3500K CRI 92
	3000K CRI 92		4000K CRI 92
	3000K CRI 97		

	2700K CRI 92		3500K CRI 92
	3000K CRI 92		4000K CRI 92
	3000K CRI 97		

Light distribution

Pendant downlights	
	Flood
	Wide flood

Pendant downlights	
	Flood
	Wide flood

Control

	Switchable
	Phase dimmable
	DALI

	Switchable
	Phase dimmable
	DALI

Colour (housing)

	White		10,000 colours *
	Black		

	White		10,000 colours *
	Black		

Colour  
(anti-glare cone)

	Silver matt		10,000 colours *
	Black		

	Silver matt		10,000 colours *
	Black		

[www.ercos.com/atrium-df-pendant](http://www.ercos.com/atrium-df-pendant)



\* available on request